

INFINIUM™ HD ENHANCED FIBRE ENCLOSURE

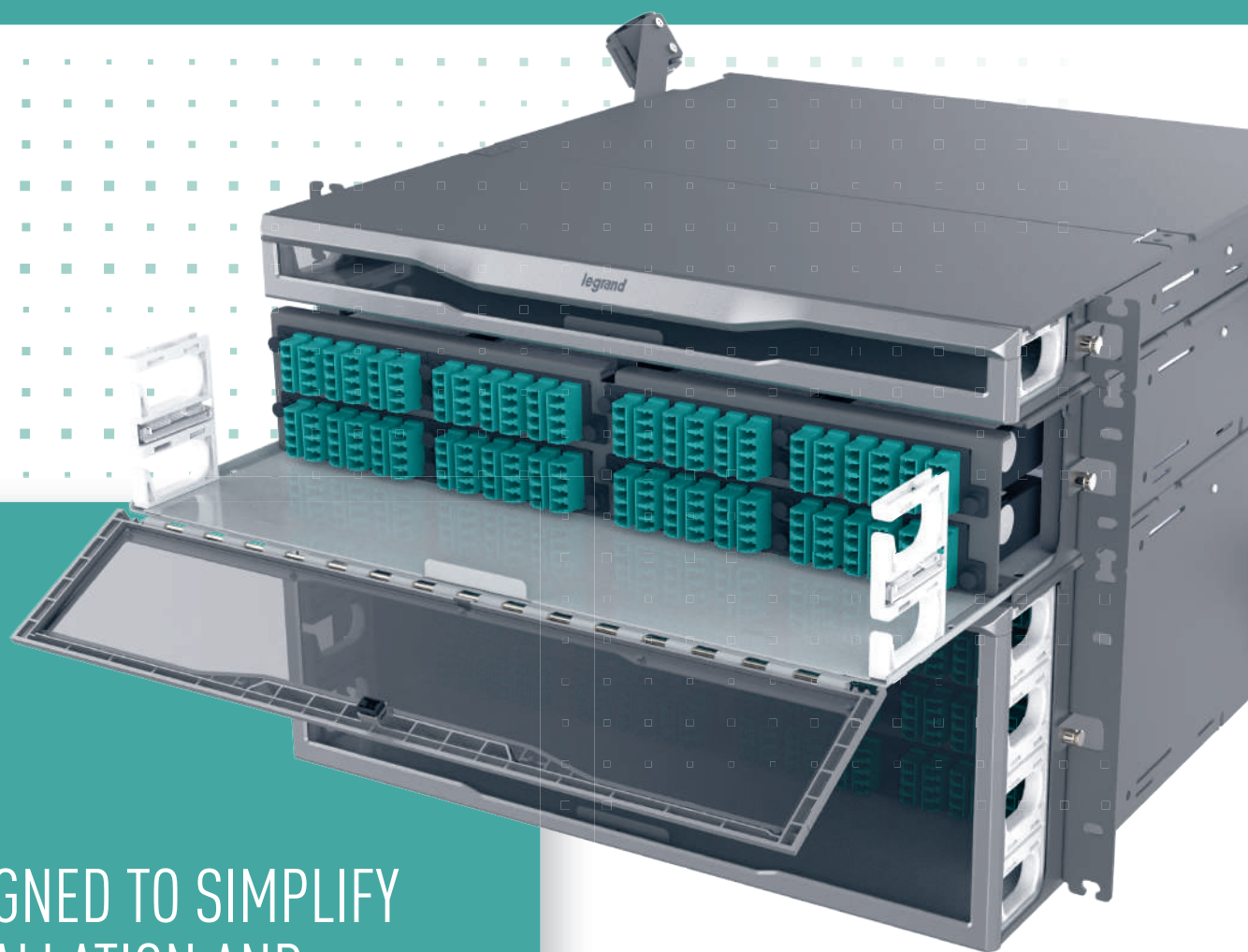

DESIGNED TO SIMPLIFY
INSTALLATION AND
IMPROVE EXPERIENCE

THE GLOBAL SPECIALIST
IN ELECTRICAL AND DIGITAL BUILDING INFRASTRUCTURES



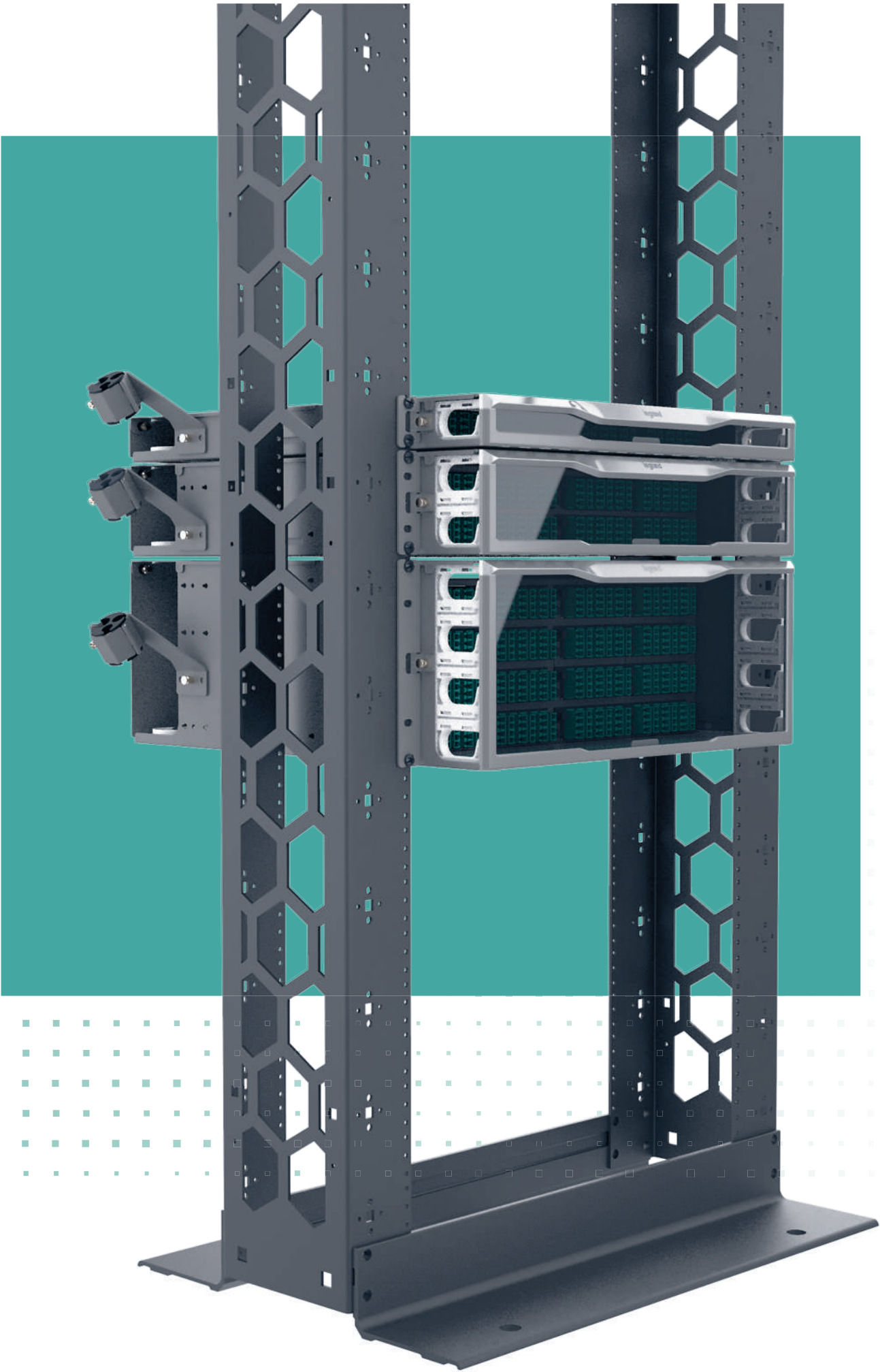

DESIGNED TO GROW WITH THE NETWORK

INFINIUM™ HD-E (ENHANCED) FIBRE ENCLOSURE

The Infinium HD-E Fibre Enclosure is an ideal solution for fibre networks in data centers and building networks. The high-density footprint accommodates up to 96 LC fibres in 1U of rack space. This enclosure has many innovative features designed with the installer, contractor, and network professional in mind, providing a simplified process when installing or working within the enclosure.

- High Density, up to 96 LC connectors in 1U of rack space
- Available in 1U, 2U, and 4U
- Accommodates 4 mounting depth positions
- Magnetic door latch
- Versitial label card mounting locations (Door or Tray)
- Forward-sliding label card
- 60/40 split tool-less top cover
- Tool-less cable attachment arms
- Pivot arms for fibre slack management
- Magnesium color scheme

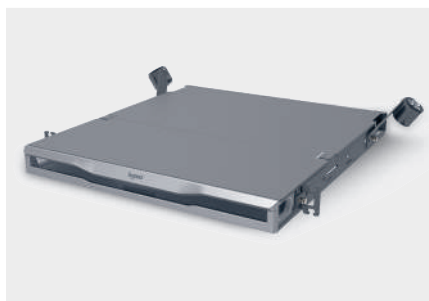

1U Enclosure



2U Enclosure



4U Enclosure

FEATURES & BENEFITS

1 BETTER ACCESSIBILITY:

The magnetic latching mechanism of the enclosure door enables a simple one handed pull to open, and push to close access. The enclosure door is attached to the sliding drawer face and tray allowing for easy clearance from equipment or other enclosures mounted below. A tray lock mechanism ensures that the tray stays in place when patching or dressing the fibre. The 60/40 split-top cover allows access from above and features tool-less removal.

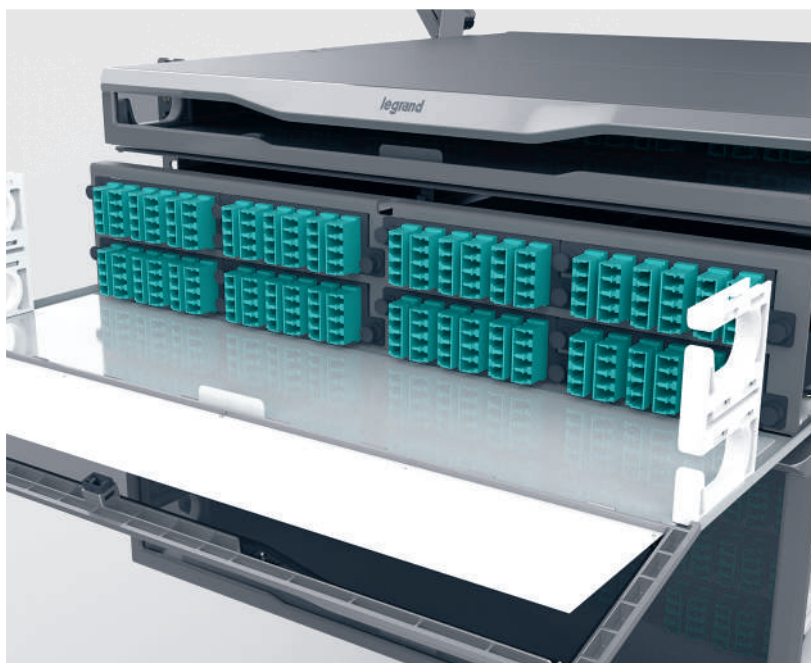

2 INCREASED VISIBILITY:

A white tray in the front and integrated LED lighting in the rear, along with the split-top cover, provide maximum visibility when working within the enclosure.



3 INTUITIVE CABLE MANAGEMENT:

The unique pivot arms provide an innovative way to manage fibre slack storage. Each arm rotates out towards the rear of the enclosure and hosts a pivot disk that may be used with slack storage spools, fan-out kits, or attachment points for securing the Legrand HiLOC harness. The Cable Attachment brackets feature tool-less adjustments for location based on which direction the cable is routed - either side of the enclosure, top or bottom. Simply make the adjustment for cable routing, load the grommet around the cable(s) and close the attachment cover.

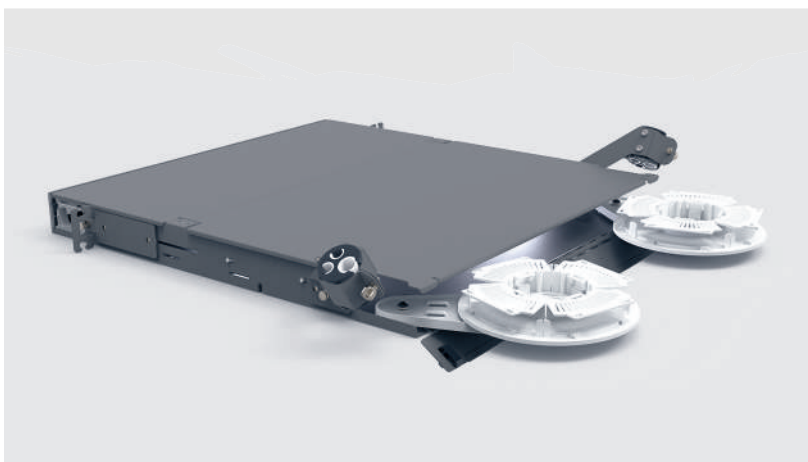
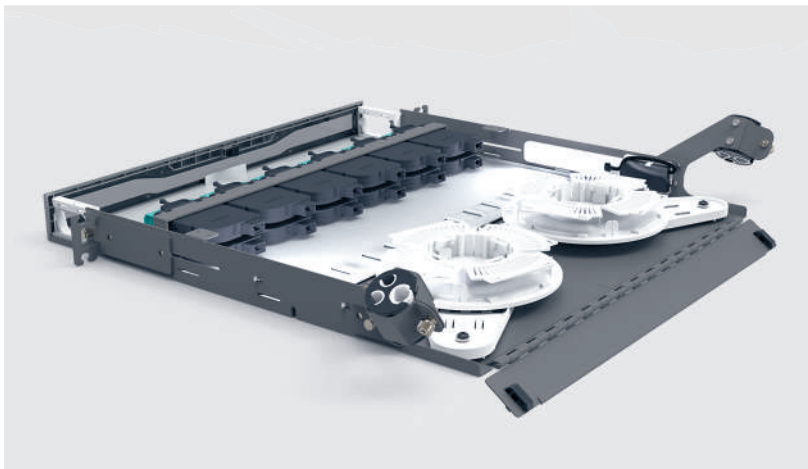

4 EASIER LABELING:

The label card is incorporated into the front door, positioning the labels directly below the ports for simple labeling and easy port identification. Templates created for both Brother and Dymo printers are available for download.

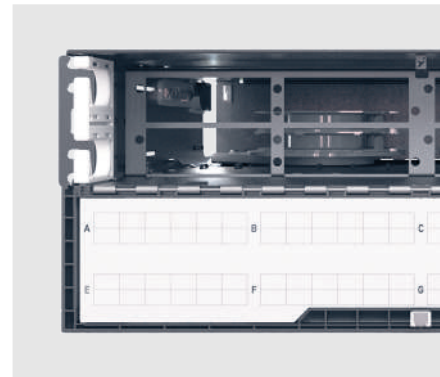

FEATURES & BENEFITS

5 GREATER SCALABILITY:

The scalable jumper management allows layers of management to be added only when needed, making it easy to keep patch cords neatly organized.

The drawer faces are removable and replaceable allowing the enclosure to easily convert between standard LM4 and optional M8 cassette and adapter footprints. This allows the enclosure scalability to support increasing bandwidth and higher speed requirements that utilize different cables, cassettes, or adapters.

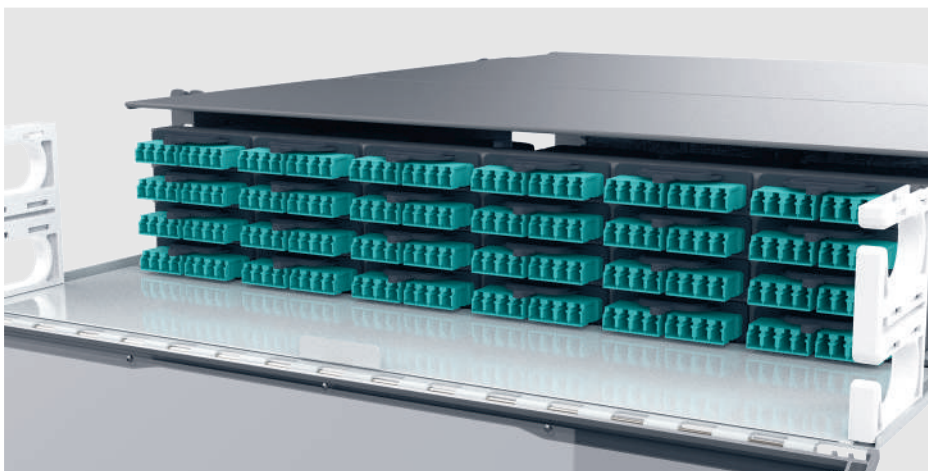
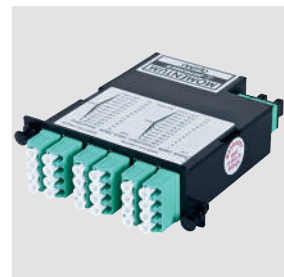

6 EASE OF INSTALLATION:

A single screwdriver is the only tool required for installing the enclosure in a rack. The mounting brackets with pin locks allow the enclosure to conveniently slide between 4 horizontal mounting positions.

The open-ended design of the mounting brackets, allows the enclosure to be installed by one person. Simply pre-mount the rack screws at the proper location on the rack, place the enclosure's mounting brackets on the pre-mounted screws to hold it in place, then tighten the screws.



7 BEAUTIFUL AESTHETICS:

This enclosure features sleek styling that matches the design of Legrand racks, cabinets and other data center products and solutions, and a magnesium color scheme that fits in all data center environments.

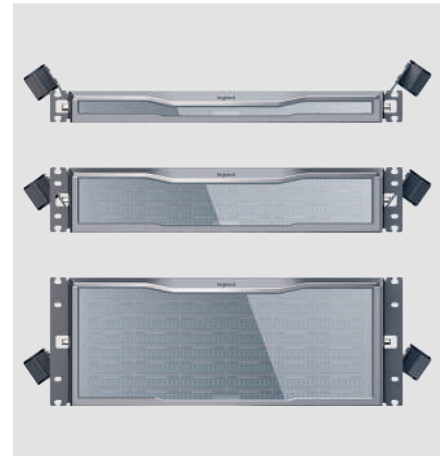

HD Infinium™ enhanced fibre enclosures

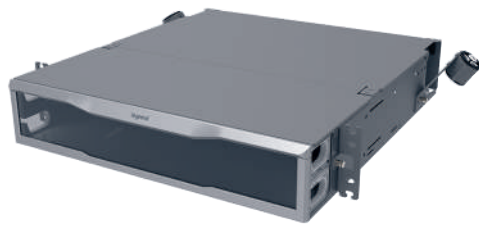

INFC01U-M4-E

Pack	Cat.Nos	HD enhanced enclosures
		High density, up to 96 LC connectors in 1U of rack space Integrated LED lighting and white tray Forward-sliding label card 60/40 split tool-less top cover Tool-less cable attachment arms Pivot arms for fibre slack management Magnesium color scheme
		With M4 (Base 12) drawer face
1	INFC01U-M4-E	1 U
1	INFC02U-M4-E	2 U
1	INFC04U-M4-E	4 U

Infinium Quantum™ cassettes

High density pre-terminated cassettes



LM4-LC12J-1A3UN



LM4-LC24H-2A4UN

Universal polarity for simple installation
 Each cassette is designed to support MPO to LC connectivity
 Pre-terminated for fastest installation, highest performance and consistent factor quality
 Industry leading performance is available only when mated with matched Infinium Quantum Trunk and Infinium Quantum Fibre Patch Cords
 Fibre port labeling provides easier administration
 Compact high density design
 Tool-less installation

Pack	Cat.Nos	Infinium Quantum M4
		Single mode
		IL ⁽¹⁾ Max/Random*: 0.375 dB
1	LM4-LC12J-1A3UN	12 Fibre MTP to Duplex LC OS2
1	LM4-LC24J-2A3UN	24 Fibre 2MTP to Quad LC OS2
1	LM4-LC24J-1A3H1	24 Fibre MTP to Quad LC OS2
		Multimode
		IL ⁽¹⁾ Max/Random*: 0.35 dB
1	LM4-LC12H-1A4UN	12 Fibre MTP to Duplex LC OM4
1	LM4-LC24H-2A4UN	24 Fibre 2MTP to Quad LC OM4

1: Insertion Loss
 *When mated with the same Legrand range (Quantum, Ultra, Core) trunks and patch cords.

For M8 drawer face,
ask your local contact

Infinium Ultra™ and Infinium Core™ cassettes - high density pre-terminated cassettes

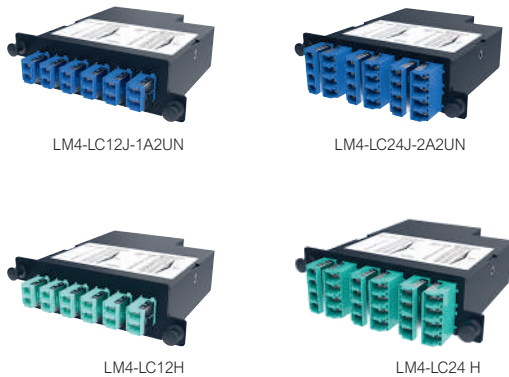

Universal polarity for simple installation
 Each cassette is designed to support MPO to LC connectivity
 Pre-terminated for fastest installation, highest performance and consistent factor quality
 Fibre port labeling provides easier administration
 Compact high density design
 Tool-less installation

Pack	Cat.Nos	Infinium Ultra M4
		Single mode IL ⁽¹⁾ Max/Random*: 0.6 dB
1	LM4-LC12J-1A2UN	12 Fibre MTP to Duplex LC OS2
1	LM4-LC24J-2A2UN	24 Fibre 2MTP to Quad LC OS2
1	LM4-LC24J-3C2UN	24 Fibre 3MTP to Quad LC OS2
		Multimode IL ⁽¹⁾ Max/Random*: 0,55 dB
1	LM4-LC12H	12 Fibre MTP to Duplex LC OM4
1	LM4-LC24H	24 Fibre 2MTP to Quad LC OM4
1	LM4-LC24H-3C3UN	24 Fibre 3MTP to Quad LC OM4
		Infinium Core M4
		Single mode IL ⁽¹⁾ Max/Random*: 1.05 dB
1	LM4-LC12J	12 Fibre MTP to Duplex LC OS2
1	LM4-LC24J	24 Fibre 2MTP to Quad LC OS2
1	LM4-LC24J-3C1UN	24 Fibre 3MTP to Quad LC OS2
		Multimode IL ⁽¹⁾ Max/Random*: 1.25 dB
1	LM4-LC12H-1A1UN	12 Fibre MTP to Duplex LC OM4
1	LM4-LC24H-2A1UN	24 Fibre 2MTP to Quad LC OM4
1	LM4-LC24H-3C1UN	24 Fibre 3MTP to Quad LC OM4

1: Insertion Loss
 *When mated with the same Legrand range (Quantum, Ultra, Core) trunks and patch cords.

INFINIUM DATA CENTER SOLUTIONS

INNOVATIVE DATA CENTER SOLUTIONS THAT YIELD INDUSTRY LEADING PERFORMANCE

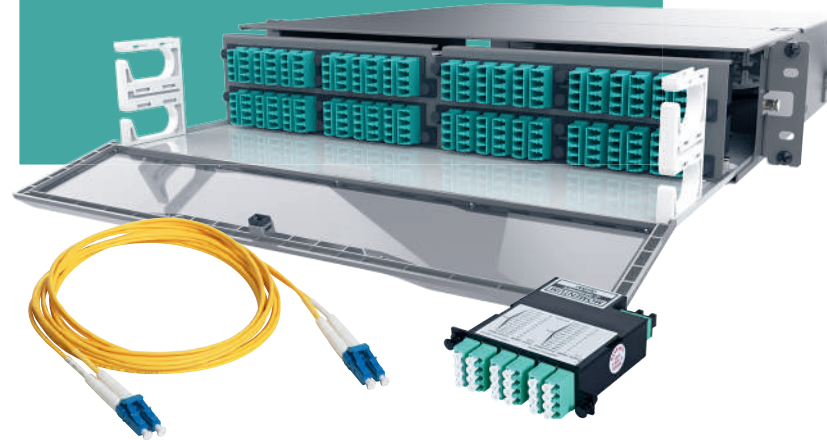

QUANTUM-LOW LOSS

INFINIUM QUANTUM

	0.75 dB Multimode	0.75 dB Single-Mode
Return Loss:	34 dB Multimode	49 dB Single-Mode

ULTRA-LOW LOSS

INFINIUM ULTRA

	1.1 dB Multimode	1.2 dB Single-Mode
Return Loss:	19 dB Multimode	55 dB Single-Mode

LOW LOSS

INFINIUM CORE

	2.5 dB Multimode	2.1 dB Single-Mode
Return Loss:	19 dB Multimode	55 dB Single-Mode

INFINIUM QUANTUM TOTAL CHANNEL CONNECTION LOSS

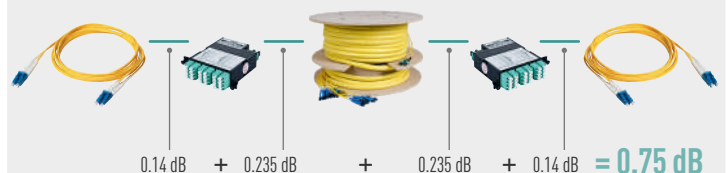

Adapter panels



HDFP-LCD12AC



HDFP-LCD12CC



HDFP-LCQ24LC



HDFP-BLANK

These high-density adapter panels fit within the M4 drawer face and provide a pass-through connection with LC duplex, LC quad, or MPO ports

Pack	Cat.Nos	M4 adapter panels
1	HDFP-LCD12AC	LC Duplex 6 LC Duplex for 12 fibre monomode OS2 Blue
1	HDFP-LCD12CC	6 LC Duplex for 12 fibre monomode OS2 Green
1	HDFP-LCD12MB	6 LC Duplex for 12 fibre multimode OM1 Beige
1	HDFP-LCD12LC	6 LC Duplex for 12 fibre multimode OM3 Aqua
1	HDFP-LCD08LC	4 LC Duplex for 8 fibre multimode OM3 Aqua
1	HDFP-LCD08AC	HD, 4 LC Duplex CER Blue
1	HDFP-SCD12AC	SC Duplex 6 SC Duplex for 12 fibre monomode OS2 Blue
1	HDFP-SCD12CC	6 SC Duplex for 12 fibre monomode OS2 Green
1	HDFP-SCD12LC	6 SC Duplex CER SM,1U,BLACK Aqua
1	HDFP-LCQ16AC	LC Quad 4 LC Quad for 16 fibre monomode OS2 Blue
1	HDFP-LCQ24CC	6 LC Quad for 24 fibre monomode OS2 Green
1	HDFP-LCQ24AC	6 LC Quad for 24 fibre monomode OS2 Blue
1	HDFP-LCQ24MB	6 LC Quad for 24 fibre multimode OM1 Beige
1	HDFP-LCQ16LC	4 LC Quad for 16 fibre multimode OM3 Aqua
1	HDFP-LCQ24LC	6 LC Quad for 24 fibre multimode OM3 Aqua
1	HDFP-MPA72AA	MPO adapter Base 12 6 MPO for fibre monomode OS2 Blue
1	HDFP-MPA72CA	6 MPO for fibre monomode OS2 Green
1	HDFP-MPA72ED	6 MPO for fibre monomode OS2 Grey
1	HDFP-MPA72LA	6 MPO for 72 fibre multimode OM3 Aqua
1	HDFP-MPA96CA	6 MPO for 96 fibre monomode OS2 Green
1	HDFP-MPA96ED	8 MPO for 96 fibre Aligned key Grey
1	HDFP-MPA96LA	8 MPO for 96 fibre multimode OM3, OM4 Aqua
1	HDFP-BLANK	Blank panel Black

Infinium Quantum™ fibre patch cords



Pack	Cat.Nos	Patch cords
	on demand	Fibre patch cords are built to exceed industry standards for insertion and return loss Available in A-B polarity, per TIA 568 standard Available with Plenum, riser, low-smoke zero halogen (LSZH), rated jackets (or CPR – rated for EU use) Bend-insensitive fibre for optimal cable management TAA/BAA Compliant TIA Channel Compliant

Ultra™ fibre patch cords



Fitted at each end with 2 connectors with ceramic ferrule
Individually packed and tested (report supplied)
Max. optical losses/Master: 0.15 dB
LSZH Zipcord sheath

Pack	Cat.Nos	OS2 single mode fibre optic cords (9/125 µm)
		For 9/125 µm single mode installations, OS2 type Yellow sheaths
		SC/SC duplex cords
5	0 325 27	Length: 1 m
5	0 325 28	Length: 2 m
5	0 325 29	Length: 3 m
		SC/LC duplex cords
5	0 325 30	Length: 1 m
5	0 325 31	Length: 2 m
5	0 325 32	Length: 3 m
		SC/LC duplex cords
5	0 325 33	Length: 1 m
5	0 325 34	Length: 2 m
5	0 325 35	Length: 3 m
5	0 325 36	Length: 5 m
		LC/LC Uniboot duplex cords
		Reversible polarity
3	0 326 86	Length: 1 m
3	0 326 87	Length: 2 m
3	0 326 88	Length: 3 m
3	0 326 89	Length: 5 m
3	0 326 92	Length: 10 m
		OM4 multimode fibre optic cords (50/125 µm)
		For 50/125 µm multimode installations, OM4 type Aqua sheaths
		SC/SC duplex cords
3	0 326 30	Length: 1 m
3	0 326 31	Length: 2 m
3	0 326 32	Length: 3 m
		SC/LC duplex cords
3	0 326 33	Length: 0.5 m
3	0 326 34	Length: 1 m
3	0 326 35	Length: 2 m
3	0 326 36	Length: 3 m
3	0 326 37	Length: 5 m
		LC/LC Uniboot duplex cords
		Reversible polarity
3	0 326 95	Length: 0.5 m
3	0 326 96	Length: 1 m
3	0 326 97	Length: 2 m
3	0 326 98	Length: 3 m
3	0 326 99	Length: 5 m

Core™ fibre patch cords

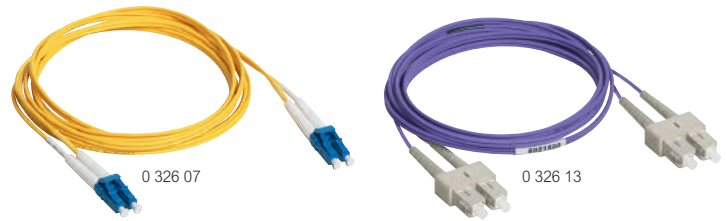

Fitted at each end with 2 connectors with ceramic ferrule
Individually packed and tested (report supplied)
Max. optical losses/Master: 0.25 dB
LSZH Zipcord sheath

Pack	Cat.Nos	OS2 single mode fibre optic cords (9/125 µm)
		For 9/125 µm single mode installations, OS2 type Yellow sheaths
		SC/SC duplex cords
3	0 326 00	Length: 1 m
3	0 326 01	Length: 2 m
3	0 326 02	Length: 3 m
		SC/LC duplex cords
3	0 326 03	Length: 1 m
3	0 326 04	Length: 2 m
3	0 326 05	Length: 3 m
		LC/LC duplex cords
3	0 326 28	Length: 0.5 m
3	0 326 06	Length: 1 m
3	0 326 07	Length: 2 m
3	0 326 08	Length: 3 m
3	0 326 29	Length: 5 m
		OM3 multimode fibre optic cords (50/125 µm)
		For 50/125 µm multimode installations, OM3 type Aqua sheaths
		SC/SC duplex cords
3	0 326 09	Length: 1 m
3	0 326 10	Length: 2 m
3	0 326 11	Length: 3 m
		SC/LC duplex cords
3	0 326 12	Length: 1 m
3	0 326 13	Length: 2 m
3	0 326 14	Length: 3 m
		LC/LC duplex cords
3	0 326 15	Length: 1 m
3	0 326 16	Length: 2 m
3	0 326 17	Length: 3 m
		OM4 multimode fibre optic cords (50/125 µm)
		For 50/125 µm multimode installations, OM4 type Aqua sheaths
		SC/SC duplex cords
5	0 322 60	Length: 1 m
5	0 322 61	Length: 2 m
5	0 322 62	Length: 3 m
		SC/LC duplex cords
5	0 322 63	Length: 1 m
5	0 322 64	Length: 2 m
5	0 322 65	Length: 3 m
		LC/LC duplex cords
5	0 322 66	Length: 1 m
5	0 322 67	Length: 2 m
5	0 322 68	Length: 3 m

To configure Infinium trunk cable, **contact us for more information about the customized offer**



FOLLOW US
ALSO ON

- legrand.com
- ▶ youtube.com/user/legrand
- f facebook.com/Legrand
- t twitter.com/Legrand
- p pinterest.com/legrandgroup
- i instagram.com/legrandnews



Headquarters

128, avenue de Lattre de Tassigny
87045 Limoges Cedex
France
Tel.: + 33 (0) 5 55 06 87 87
Fax: + 33 (0) 5 55 06 88 88