

# PUTTING A STOP TO ENERGY WASTE



## SWITCH SENSORS

DESIGN AND  
APPLICATION GUIDE



CATALOGUE  
PAGES  
INSIDE  
→

THE **GLOBAL SPECIALIST**  
IN ELECTRICAL AND DIGITAL BUILDING INFRASTRUCTURES

 **legrand**<sup>®</sup>



according to EN 15193

Our vision at Legrand is to provide products and services that make buildings more energy efficient. We are committed to putting a stop to energy waste.

This document will help you in selecting, laying out, installing and commissioning a lighting management solution. It will also help you in defining and implementing the optimum lighting management solution for specific type of building space.



# CONTENTS

- p. 1 | Design steps for implementing motion & lighting management solutions
- p. 13 | Application examples for specific building spaces
- p. 22 | Catalogue pages

# DESIGN STEPS FOR IMPLEMENTING MOTION & LIGHTING MANAGEMENT SOLUTIONS

Our wide range of switch sensors, comprising Motion and Lighting Management sensors, is designed to reduce the amount of time lighting is left on unnecessarily, for example if an area is unoccupied or if there is sufficient natural light.

Our Lighting Management sensors can be used to:

**monitor the detection area for occupancy**

- When a person is sensed the lighting is automatically switched on.  
In case of sensors equipped with a built in light level sensor, the lighting will be kept off when enough natural light is available.

- When the area is vacated: the lighting is switched off after a preset time delay.

**control lighting** (up to 60% savings on lighting energy costs according to EN 15193).

**control HVAC circuits and roller blind circuits** (either via the sensor or a room controller).

**In our range, you are sure to find the Motion or Lighting Management sensor that will suit any area and control your lighting efficiently.**

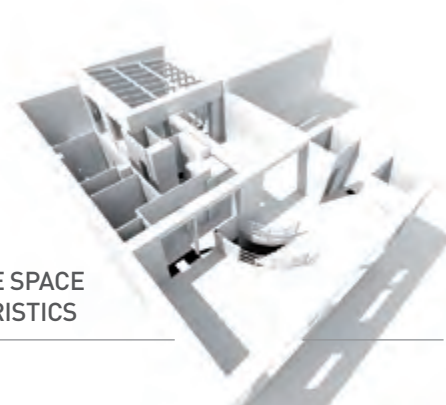

## 1 ASSESS THE SPACE CHARACTERISTICS

## 2 CHOOSE THE RIGHT SWITCH SENSOR

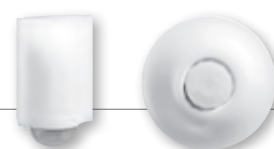

## 3 DEFINE THE BEST LOCATION



## 4 CONFIGURE THE SENSORS

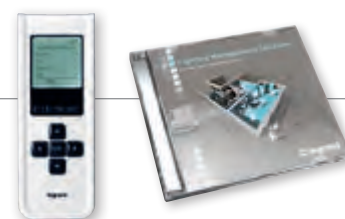

## STEP 1

# ASSESS THE SPACE CHARACTERISTICS

There is a dedicated solution for each area (type, configuration, activity, etc.). It is therefore essential to take the following criteria into account:

- room/space size and shape (number of m<sup>2</sup>)
- occupant activity and non-activity areas
- location of walls, doors and windows
- partition height and location
- ceiling height
- areas benefiting (or not) from natural light
- location of shelves, book cases, file cabinets, and large equipment
- large objects that would block or alter a sensor's coverage
- location of HVAC ducts and fans
- location of desk/workspace – orientation with regard to walls, partitions and other obstacles.

To ensure you a perfect installation of the sensors and the best quality detection, here are some application examples:

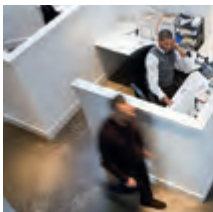
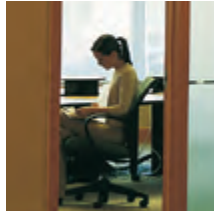

P. 14  
OUTDOOR CAR PARK

P. 15  
WAREHOUSE

P. 16  
STAIRWAY

P. 17  
CORRIDOR

P. 18  
INDIVIDUAL OFFICE

P. 19  
CLASSROOM

P. 20  
OPEN SPACE

P. 21  
MEETING ROOM



**Special attention should be paid to high levels of vibration and/or air flow, extreme temperature conditions, and unusually low levels of activity because these issues may help identify the best technology solution**

# STEP 2 CHOOSE THE RIGHT SENSOR

Legrand has 2 categories of sensor according to the area concerned and the type of detection:

## MOTION SENSORS

- For areas with little or no natural light.
- For passageways.
- Automatic switch-on/off according to whether or not there is anyone present.

## LIGHTING MANAGEMENT SENSORS

- For areas with natural light.
- For passageways and/or work areas.
- Manual or automatic switch-on and automatic switch-off, according to whether or not there is anyone present and the natural light level.
- Dimming and HVAC/roller blind control for BUS sensors used with controllers.
- Can be adjusted using configuration tool.

## MOTION SENSORS

### For areas with no natural light

These sensors are particularly suitable for areas where there is no natural light, and for passageways such as bathrooms, corridors, equipment rooms, etc.

### 1 DETECTION TECHNOLOGY:

- Passive infrared (PIR) technology**  
 Passive infrared technology detects occupancy by reacting to infrared energy sources, such as a human body in motion.

### 2 COVERAGE PATTERNS

Cat.Nos	Installation type Technology	Range	Detection area	Examples of applications
 0 488 03		8 m		Corridor, stairways, restrooms etc.
 0 697 40		8 m		Utility room, car park, cellar etc.
 5 740 47 5 740 34		8 m		Corridor, stairways, restrooms etc.
 0 489 11 0 489 31		8 m		Corridor, stairways, restrooms (IP 42) Utility room, car park, cellar (IP 55)

# LIGHTING MANAGEMENT SENSORS

## For areas with natural light

These sensors are particularly suitable for areas with natural light, whatever the type of building: shops, offices, healthcare buildings, recreation areas, warehouses or workshops, etc.

The sensors have built-in adjustable lux sensors:

- lighting Management sensors will keep the lighting switched off if there is sufficient natural light
- lighting Management sensors associated with room controllers will dim automatically while maintaining a pre-set lux level according to natural daylight and will control several lighting and ventilation circuits.

### 1 DETECTION TECHNOLOGY

 **Passive infrared (PIR) technology**  
Passive infrared technology detects occupancy by reacting to infrared energy sources, such as a human body in motion.

 **Dual technology (DT)**  
Sensors that employ PIR + US sensing technologies are usually referred to as “dual technology”. Our Dual technology ensures maximum sensitivity and coverage in tough applications for optimum reliability and energy saving.

### 2 PRODUCT FEATURES

#### 2-1. Occupancy and vacancy detection

##### Vacancy/Occupancy mode selection

Most Legrand sensors can work using occupancy mode (by default) or vacancy mode.

 Occupancy mode means that lights are automatically switched on or off according to occupancy.

 Vacancy mode means that lights are manually switched on and automatically switched off. Vacancy mode offers extra energy savings.



#### OCCUPANCY MODE



Sensors will switch on lighting automatically when a person enters the room, and switch lighting off automatically when no movement is detected.

##### Application:

energy saving and cost effective, can be used instead of a conventional switch.



#### VACANCY MODE



Upon entering the room the person switches on the light as normal, but on leaving the sensor switches off the lighting automatically. Lights can also be switched off manually.

##### Application:

commonly used for improved energy saving and to comply with regulations.

## 2-2. Daylight



### Daylighting set point = Regulation

The light level feature keeps the lighting OFF when natural light levels rise above a pre-set level. This setting is adjustable and can be overridden. This function is enabled by default.

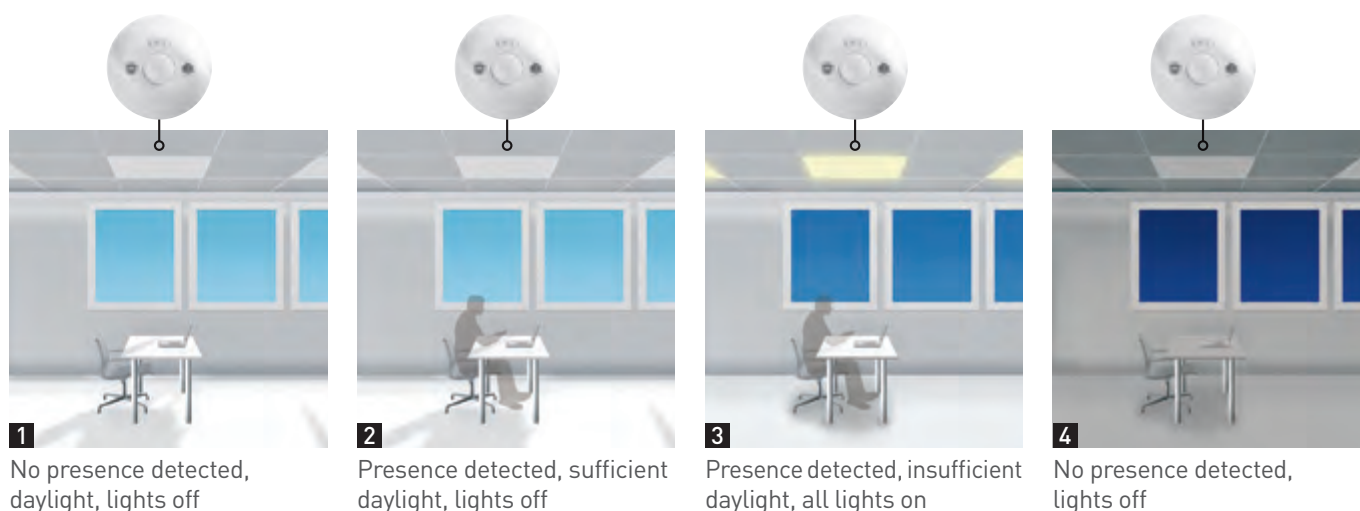

### 3 COMBINATION: SENSOR + ROOM CONTROLLERS

Sensors can be combined with a room controller to manage a number of circuits in passageways with natural light, outdoors, damp areas or in work areas.

Combining a sensor and a room controller provides additional functions to:

- lighting management: on-off or dimming (DALI, 1-10 V, halogen/incandescent/LED).  
Eg: dimming the window side (access to natural light) and the corridor side separately.
- your installation: blinds, heating, fan control etc.

This combination makes your building flexible and gives you more energy savings.

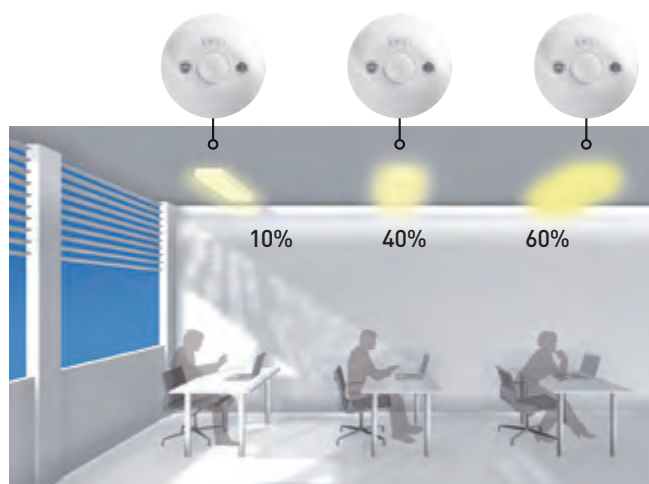











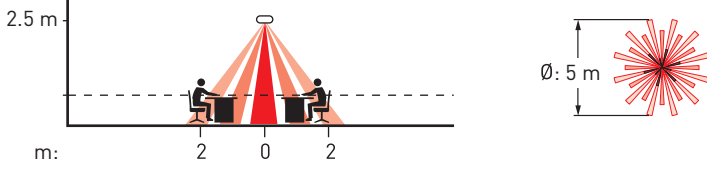

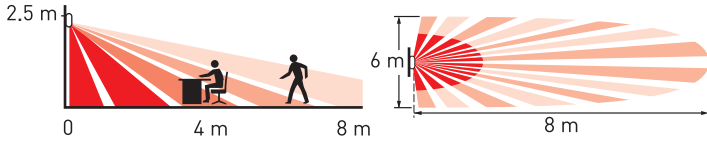
#### The daylight is unevenly distributed in an area

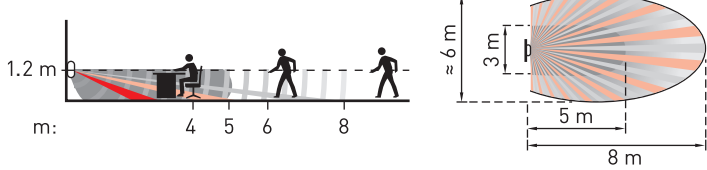
A sensor is combined with each row of luminaires and measures presence and light level. The dimming controller regulates each row of luminaires and supplements the external light to obtain the required light level.

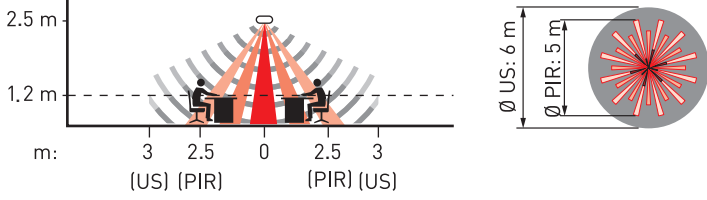
# STEP 2 \_ CHOOSE THE RIGHT SENSOR

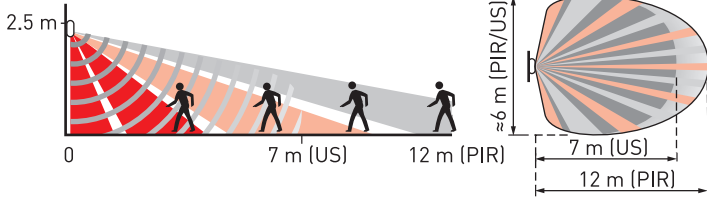
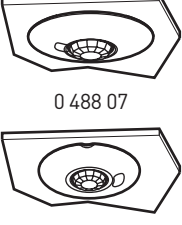

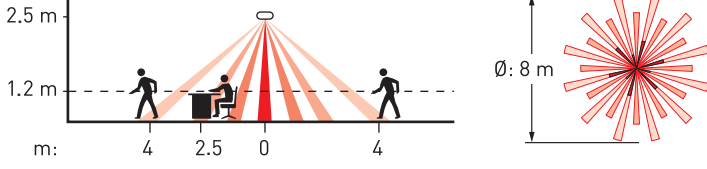







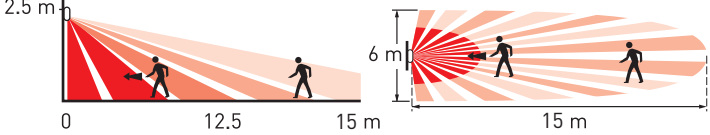

## 4 COVERAGE PATTERNS

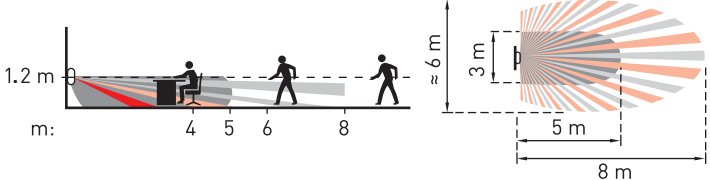
Cat.Nos	Installation type Technology	Range	Detection area	Examples of applications
 0 488 04 <sup>(1)</sup>		5 m		Individual office, corridor, stairways, restrooms etc.
 0 489 14 <sup>(1)</sup>		8 m		Individual office
 5 740 79 5 740 31 <sup>(2)</sup>		8 m		Individual office, classroom, meeting room, open plan office
 0 488 06/09		6 m (US) 5 m (PIR)		Classroom, meeting room, open plan office
 0 489 16 <sup>(1)</sup>		7 m (US) 12 m (PIR)		Individual office, classroom, meeting room, restrooms etc.
 0 488 07 0 488 08		8 m		Hall, stairways etc.

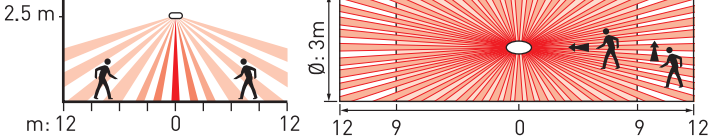
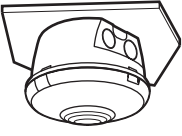
<sup>(1)</sup> 1 lighting output & 1 fan output

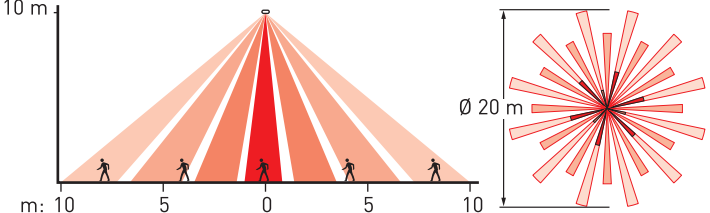
<sup>(2)</sup> without neutral



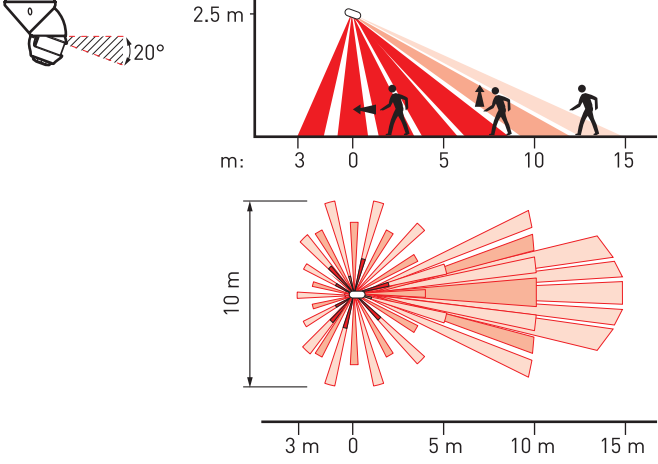









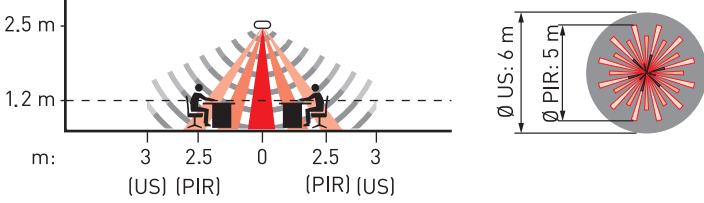

Cat.Nos	Installation type Technology	Range	Detection area	Examples of applications
 0 489 17 <sup>(1)</sup>		15 m		Hall, stairways, very long areas
 5 740 47 5 740 34 <sup>(2)</sup>		8 m		Hall, stairways
 0 488 17		2 x 12 m		Long corridor
 0 489 32		∅ 20 m		High ceiling areas (Warehouses, gymnasium)
 0 489 33	 	18 m		High ceiling areas (Warehouses, gymnasium) outdoor car park, cellar, laboratory

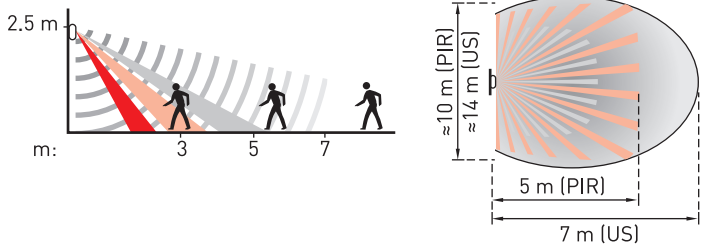
<sup>(1)</sup> 1 lighting output & 1 fan output

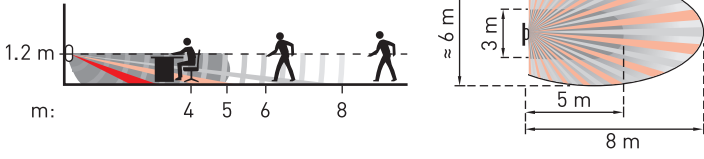
<sup>(2)</sup> without neutral

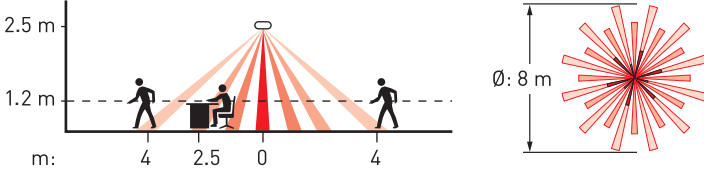
# STEP 2 \_ CHOOSE THE RIGHT SENSOR

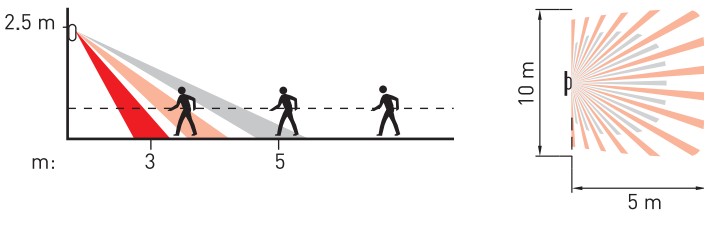
## 4 ROOM CONTROLLER

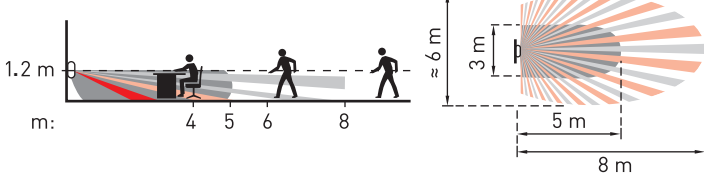
Cat.Nos	Installation type Technology	Range	Detection area	Examples of applications
 0 488 22		6 m (US) 5 m (PIR)	 <p>2.5 m 1.2 m m: 3 2.5 0 2.5 3 (US) (PIR) (PIR) (US)</p> <p>∅ US: 6 m ∅ PIR: 5 m</p>	Individual office, classroom
 0 488 23		7 m (US) 5 m (PIR)	 <p>2.5 m m: 3 5 7</p> <p>≈ 10 m (PIR) ≈ 14 m (US) 5 m (PIR) 7 m (US)</p>	Individual office, classroom
 5 740 48		8 m	 <p>1.2 m m: 4 5 6 8</p> <p>≈ 6 m 3 m 5 m 8 m</p>	Individual office, classroom
 0 488 20		8 m	 <p>2.5 m 1.2 m m: 4 2.5 0 4</p> <p>∅: 8 m</p>	Restrooms, changing room
 0 488 24		5 m	 <p>2.5 m m: 3 5</p> <p>10 m 5 m</p>	Restrooms, changing room
 5 740 46		8 m	 <p>1.2 m m: 4 5 6 8</p> <p>≈ 6 m 3 m 5 m 8 m</p>	Restrooms, changing room

Cat.Nos	Installation type Technology	Range	Detection area	Examples of applications
 0 488 25		27 m		Corridors, very long corridor
 0 488 30		10 m		Outdoor car park, cellar, laboratory, test rooms

## 5 ROOM CONTROLLER - CONTROL OF CIRCUITS

In order to control several circuits (lighting, fans, blinds), Lighting Management sensors can be used with room controllers.

The following chart indicates which room controller to use:

	ON-OFF	DIMMING		
		DALI	1-10 V	HALOGEN  - INCANDESCENT  - DIMMABLE LEDS <sup>(1)</sup>
<b>1 lighting circuit in the same room</b>	0 488 50	0 488 51	0 488 52	0 488 45
<b>1 lighting circuit + fan output in the same room</b>	0 488 50	0 488 51	0 488 52	-
<b>2 lighting circuits in the same room</b>	0 488 50	0 488 51	0 488 52	0 488 45
<b>2 lighting circuits + 1 fan output in the same room</b>	-	0 488 51	-	-
<b>2 lighting circuits (2 inputs, 2 outputs) in 2 rooms</b>	0 488 41	-	0 488 42 (1000 VA)	0 488 45
<b>4 lighting circuits (4 inputs, 4 outputs) in 4 rooms</b>	0 488 43	0 488 44 (max. 32 ballasts)	0 488 43	-
<b>2 lighting circuits + 1 blind output + 1 fan output (4 inputs, 4 outputs) in the same room</b>	0 488 47	-	0 488 47	-

<sup>(1)</sup> Refer to the load table in the data sheet available online in the e-catalogue (**Note:** some commercially available dimmable LEDs are not compatible).

## STEP 3

# DEFINE THE BEST LAYOUT

Whether it is a matter of work areas or passageways, the presence sensors must be chosen and positioned in line with the following recommendations:

### 1 WORK AREAS

These are areas in which people spend time, such as individual or open plan offices, meeting rooms, classrooms, etc.

#### Positioning

For optimum detection, the sensor must have an unobstructed view (no obstacles in the sensor's detection field).



People who are seated must be completely within the area to be monitored, and preferably as close as possible to the sensor (the detection area for seated people is much smaller than that for people who are moving around).

In small spaces preference should be given to wall-mounted sensors placed in a corner. In large, open plan offices preference should be given to ceiling sensors (with their detection areas overlapping).

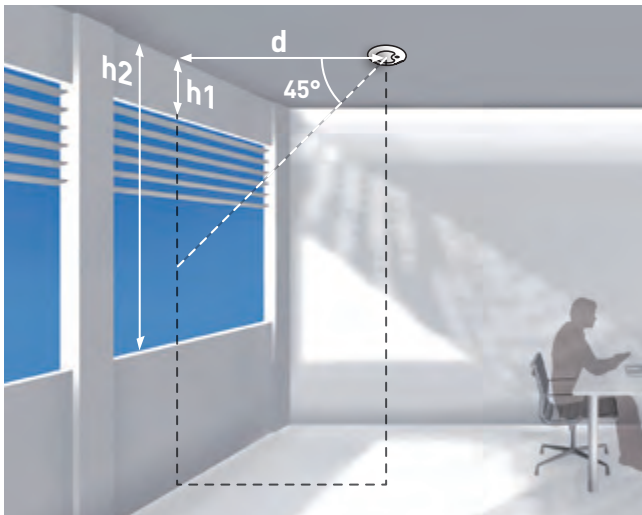

For optimum light level measurement, the sensor must be positioned between a minimum distance (to be determined) and 4 metres maximum from the source of natural light (large or small window, etc.). The ideal distance is calculated using the formula  $d = (h_1 + h_2) / 2$ .

#### Recommendations

The presence sensors must not:

- be positioned less than 1 m from sources of heat or cold (radiators, air conditioning units, etc.) which could cause "false detection"
- have a luminous flux (luminaire, window) in direct view, to ensure correct measurement of the light level.

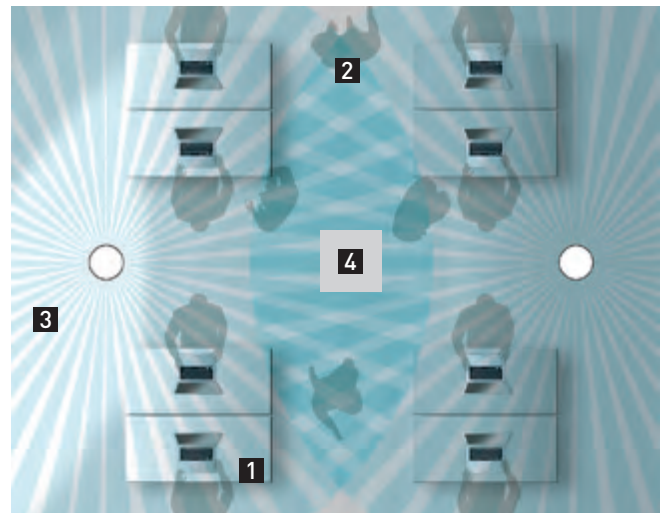

- 1- Seated person
- 2- Moving person
- 3- Window
- 4- Air conditioning unit

- **Dual technology detection** should be given preference as it combines 2 detection technologies (IR + US), providing very reliable detection of people who are seated.

## 2 PASSAGEWAYS

These are areas in which people “move around”, such as corridors, halls, stairways, archive areas, toilets, etc.

### Positioning

For optimum detection, the sensor must have an unobstructed view (no obstacles in the sensor’s detection field).

The following types of presence sensor can be used:

- for wall mounting, with an 180° detection area
- for ceiling mounting, with long range detection areas.



The detection areas in horizontal or vertical spaces where people move around must overlap, to avoid any blind spots.

The transverse detection performance is more important than the radial performance.

### Recommendations

Access points (doors) must be fully covered by the detection areas.

The sensors must not have any luminous flux (luminaire, window) in direct view, to ensure correct measurement of the light level.

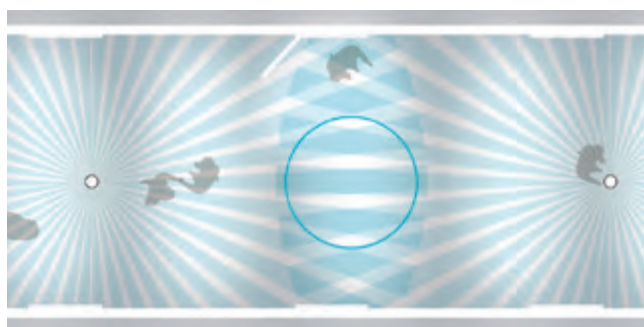

- **PIR detection** should be given preference. It provides good detection performance for people moving around, with a long detection range.

## STEP 4

# CONFIGURE THE SENSORS

Lighting Management sensors are factory pre-set. The configuration tool, Cat.No 0 882 30, can be used to configure the sensors with customised settings by sending and receiving data via infrared: easy set-up and maintenance guaranteed! The following functions can then be adjusted:



### Time delay

Each time there is a movement, a time delay – or inner clock – is restarted. The light stays on until this time delay has elapsed, as the room is considered to be occupied.

#### Recommendation:

10 to 15 minutes for work areas, 5 minutes for passageways.



### Daylight setpoint

Value at which the load comes on if light level is below the light setting and goes off if it is above this threshold. The Daylight setpoint can be set up to a maximum of 1275 lux.

#### Recommendation:

passageway and corridors: 100 lux  
stairways: 150 lux  
offices: 300 - 500 lux.



### Sensitivity

For each technology, the sensitivity setting is used to:

- reduce or increase the detection area
- reduce the disturbing effects of air currents, air conditioning and air flows from heating.

To set the sensitivity levels, go to the detection area and check that the sensor covers the strategic positions in the room (entrance door, desk).



### Calibration

In order to set this calibration, it is necessary to measure the surrounding light level using a luxmeter beforehand. The surrounding light level measured must then be transmitted to the sensor.

#### Steps for regulating the electric light factor:

- switch the light on and close the blinds
- wait 2 minutes
- measure the light level below the cell using a luxmeter.

Enter this value in the tool and send it to the cell. This calibration will be acknowledged during the next detection cycle.

## 4 DIFFERENT OPERATING MODES



### Occupancy (Auto on/Auto off mode)

Automatic switch-on:

- n detection of presence if there is an insufficient natural level of light.

Automatic switch-off:

- if no presence is detected and at the end of the time delay set
- or if there is a sufficient level of natural light (activated light regulation).

Any new detection causes an automatic switch on if there is insufficient light.

### Walkthrough

- If there is no presence detected in the 20 seconds following an initial detection, the sensor will switch off after 3 minutes.
- If a new presence is detected in the 3 minutes following the initial detection, the device will switch off at the end of the time delay set.



### Vacancy (Manual on/Auto off mode)

Manual switch-on, automatic switch-off:

- where no presence is detected and at the end of the time delay set.

Following switch-off, any new detection within a 30-second period will cause the device to be switched on automatically. After 30 seconds, the device is switched on via a manual switch.

### Partial on/Group off mode

This mode is used to ungroup circuits that are switched on on detection and switched off at the end of detection.

Example: on detection I switch on the main lighting and occasional lighting can be controlled manually at the same time. At the end of detection, the sensor orders the main lighting and the occasional lighting circuits to be switched off.

MOBILE CONFIGURATOR:

MOBILITY  
FOR SET-UP AND  
MAINTENANCE

LEGRAND EXCLUSIVITY



# APPLICATION EXAMPLES FOR SPECIFIC BUILDING SPACES





# Outdoor parking



Switch-on and switch-off must be automatic according to whether or not the area is occupied and the natural light level. The sensor must withstand outdoor stresses.

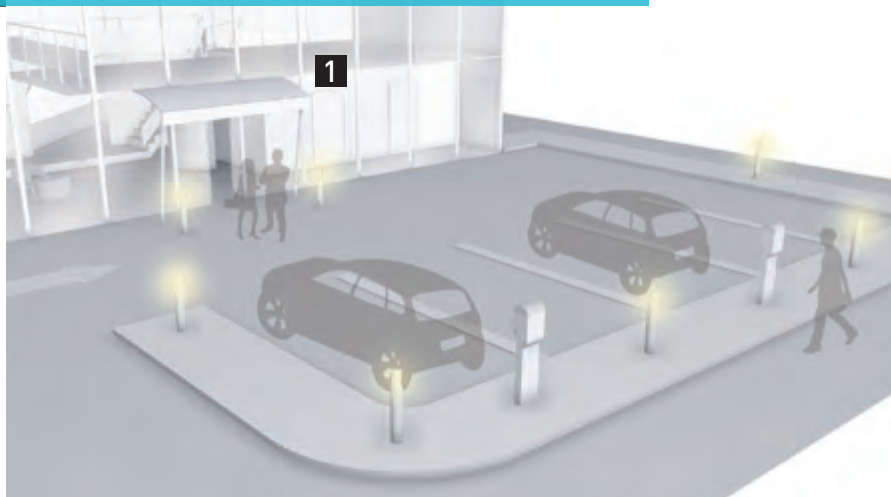

## CONTROL REQUIREMENTS

Lighting is automatically switched ON & OFF.

### Switch-on

Automatic by presence detection as soon as the natural light level is insufficient.

### Switch-off

Automatic when the area is no longer occupied after a time delay, or as soon as the natural light level is sufficient.

## SOLUTIONS

**1** Use PIR sensors to provide a large coverage area in terms of length & width.



### Cat.No 0 489 33

PIR outdoor motion sensor  
270° with directional head  
Range 20 m  
IP 55  
For wall or ceiling mounted  
Fixed above a door, its double lens will switch on the lights as soon as the door opens. It will also provide detection over very long areas.

OR



### Cat.No 0 697 40

Adjustable PIR outdoor motion sensor  
Directional head to make sure lights switch on as soon as the door opens.  
360°  
Range Ø 8m  
IP 55  
Surface-mounting, on wall or ceiling.



# Warehouse high bay



Switch-on and switch-off must be automatic according to whether or not the area is occupied and the natural light level. The sensor must have a detection range suitable for very high areas.



## CONTROL REQUIREMENTS

Lighting is switched ON & OFF automatically.

### Switch-on

Automatic by presence detection.

### Switch-off

Automatic when the area is no longer occupied after a time delay, or as soon as the natural light level is sufficient.

## SOLUTIONS

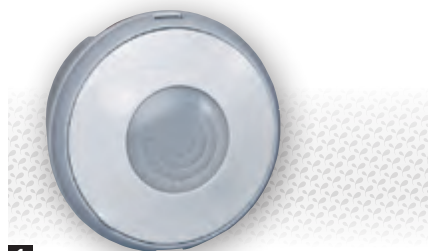

1

### Cat.No 0 489 32

PIR sensor  
360°  
Range Ø 20 m  
IP 55 (IP 66 with plastic cable glands)  
Surface mounting on ceiling.

# Stairway



Switch-on must be triggered by a person passing and switch-off must be automatic after he/she has left.



## CONTROL REQUIREMENTS

Lighting switched ON & OFF automatically with a motion sensor installed on each floor.

### Switch-on

Automatic by presence detection as soon as the natural light level is insufficient.

### Switch-off

Automatic when the area is no longer occupied, after time delay.

## SOLUTIONS



OR



1

### Cat.No 0 697 40

Adjustable PIR motion sensor  
Directional head to detect people mounting stairs  
360°  
Range Ø 8 m  
IP 55  
Surface-mounting on wall or ceiling  
(one sensor per floor).

### Cat.No 0 784 57

PIR sensor  
Replace your push-buttons wired to a timer without changing the wiring  
180°  
Range 8 m  
Auto ON/OFF  
IP 41  
Wall-mounting.

# Corridors



Switch-on must be triggered by a person passing and switch-off must be automatic after he/she has left, but only if there is insufficient natural light.



## CONTROL REQUIREMENTS

Lighting is switched ON & OFF automatically.

### Switch-on

Automatic by presence detection as soon as the natural light level is insufficient.

### Switch-off

Automatic when the area is no longer occupied after a time delay, or as soon as the natural light level is sufficient.

## SOLUTIONS

- 1 Use PIR corridor sensors to provide long range front detection & ensure the detection areas overlap so that occupants are not left in the dark.



**Cat.No 0 488 17**  
Infrared dual detection sensor  
2x180°  
Side range 2 x 12 m  
IP 20  
Ceiling mounted.

**Cat.No 0 489 17**  
PIR sensor  
180°  
Range 25 m  
IP 42  
Surface mounted on a wall can be mounted in/on a corner using accessory.

Using 100 lux & a 5 minute time delay will provide the right level of lighting and maximum energy savings.



**For installation of 2 circuits:**  
1/3 luminaires is permanent, controlled by a timer, the other 2/3 are controlled by motion sensors

# Individual office



Switch-on and switch-off must be automatic according to whether or not the office is occupied and the natural light level.



## CONTROL REQUIREMENTS

Lighting and fan are switched ON manually and switched OFF automatically or manually.

### Switch-on

Manual via push-button.

### Switch-off

- As soon as the natural light level is sufficient.
- Automatic by detection that there is no-one present in the office (after time delay).
- Manual using the push-button.

## SOLUTIONS

**1** Use dual-tech sensors to provide precise detection & avoid false switch-off.



**Cat.No 0 488 06**  
Dual-tech sensor  
360°  
Range Ø 8 m  
Manual ON-Auto OFF  
Daylight control - 300 lux  
IP 20 - Ceiling mounted.

**Cat.No 5 740 49**  
Dual-tech sensor  
180°  
Maximum range 8 m  
Manual ON-Auto OFF  
Daylight control - 300 lux.  
IP 41  
Wall-mounting.

**Cat.No 0 488 04**  
PIR sensor  
360°  
Range Ø 5 m  
High density lens with fan control IP 41  
Ceiling mounted.

**2** The push-button **Cat.No 5 720 31** can be used to control lighting circuits manually.



Using 350 lux & a 10 minute time delay combined with Vacancy detection will ensure maximum energy savings.



# Classroom

2

3



The lighting is dependent both on whether the areas are occupied and on differences in the natural light level in the classroom.

An additional manual control can be used to dim the lighting.



## CONTROL REQUIREMENTS

Lighting is switched ON manually and switched OFF automatically or manually.

### Switch-on

Manual via push-button for the room and the board.

### Switch-off

- As soon as the natural light level is sufficient.
- Automatic when the area in the classroom is no longer occupied, after a time delay. Automatic switch-off of the board lighting is linked to that of the classroom lighting.
- Manual using the push-button.

### Lighting regulation

The amount of artificial lighting is adapted according to the natural light, so that a minimum lighting level is constantly maintained.

Note: users can adjust the light level to their own requirements using the push-button. Automatic management will take over again while the user is absent. The area on the window side will thus have a lower level of artificial light than that on the opposite side.

## SOLUTIONS



1

**Cat.No 0 488 22**  
Dual-tech occupancy sensor  
Range Ø 20 m  
IP 20  
Ceiling mounted.



2

**Cat.No 0 488 51**  
Room controller for DALI and DSI dimming  
Occupancy mode, vacancy mode.  
The room controller applies a dimming difference of 30, 50 or 80% between the window and the corridor side.  
Fixed directly to the false ceiling via cable ducting.

3

The push-button **Cat.No 5 720 31** can be used to control lighting circuits manually.

# Open space



The lighting must adapt to whether or not the office areas and aisles are occupied, while taking the natural light level into account.



## CONTROL REQUIREMENTS

Lighting is switched ON manually and switched OFF automatically or manually.

### Switch-on

Manual via push-button or touch screen.

### Switch-off

- Gradual, as soon as the natural light level is sufficient.
- Automatic when the area in the open plan office is no longer occupied (after a time delay).
- Manual via push-button or touch screen.

### Lighting regulation

The amount of artificial lighting is adapted according to the natural light, so that a minimum lighting level is constantly maintained.

Note: users can adjust the light level to their own requirements using the push-button. Automatic management will take over again while the user is absent.

The area on the window side will thus have a lower level of artificial light than that on the opposite side.

## SOLUTIONS



**1**  
**Cat.No 0 488 22**  
Dual-tech occupancy sensor  
Range Ø 8 m  
IP 20  
Ceiling mounted.



**2**  
**Cat.No 0 488 44**  
Dimming room controller for DALI protocol  
Fixed directly to the false ceiling via cable ducting.

**3** The push-button **Cat.No 5 739 87** can be used to control control and dim lighting circuits manually.

**4** The touch screen **Cat.No 5 739 58** can be used to activate scenarios.

# Meeting room



Room occupants must be able to control and dim the light and also the blinds, screen and ventilation according to their requirements.



## CONTROL REQUIREMENTS

Lighting and fan are switched ON manually and switched OFF automatically or manually.

### Switch-on

Manual via push-button or touch screen.

### Switch-off

- Gradual, as soon as the natural light level is sufficient.
- Automatic by detection that there is no-one present in the meeting room (after time delay).
- Manual via push-button or touch screen.

### Lighting regulation

The amount of artificial lighting is adapted according to the natural light, so that a minimum lighting level is constantly maintained.

Note: users can adjust the light level to their own requirements using the push-button. The area on the window side will thus have a lower level of artificial light than that on the opposite side.

The scenario push-buttons, remote control or touch screen can be used to activate projection, end of projection, full light, etc. scenarios. The ventilation will switch from ECO mode to COMFORT mode when the presence of a person is detected.

## SOLUTIONS



**1**  
**Cat.No 0 488 22**  
Dual-tech occupancy sensor  
Range Ø 8 m  
IP 20  
Ceiling mounted.

**2**  
**Cat.No 0 488 47**  
Multi-application room controller:  
• 2 x 1-10 V dimming output  
• 1 blind output  
• 1 fan output  
Fixed directly to the false ceiling via cable ducting.

- 3** The push-button **Cat.No 5 739 87** can be used to control and dim lighting circuits manually.
- 4** The touch screen **Cat.No 5 739 58** can be used to activate scenarios.
- 5** An additional remote control **Cat.No 0 882 32** can bring more flexibility for the occupants.

# Motion and Lighting Management sensors for 1 circuit

## selection chart

MOTION SENSORS			
AREAS WITHOUT NATURAL LIGHT	INSTALLATION		
	Ceiling	Wall	
		Surface mounting <sup>(2)</sup>	Flush-mounting <sup>(1)</sup>
<b>PASSAGEWAY</b>			
Hall/lobby Stairways/hallways Storage areas/technical areas	 0 488 03 <sup>(1)</sup>	 0 489 11	 5 740 47 <sup>(1)</sup> 5 740 34 <sup>(4)</sup> - Without neutral
<b>OUTDOOR AND DAMP AREAS</b>			
Indoor/external car park Indoor entrance areas <b>IP 55</b>	 0 697 40/0 697 80	 0 489 31 Fixed head  0 697 40 Directional head	-

LIGHTING MANAGEMENT SENSORS			
AREAS WITH NATURAL LIGHT	Automatic On-Off Checking permanently the presence and daylight level		
	<b>WORK AREAS</b>		
Individual office/small room	 0 488 00/0 488 04 <sup>(3)</sup>	 0 489 14	 5 740 49/5 740 31 <sup>(1)</sup>
Open plan office/classroom/ meeting room	 0 488 06 <sup>(1)</sup> 0 488 09	 0 489 16 <sup>(3)</sup>	 5 740 49/5 740 31 <sup>(1)</sup>
<b>PASSAGEWAY</b>			
Hall/lobby Stairways/hallways	 0 488 07 <sup>(1)</sup> 0 488 08 <sup>(1)</sup>	 0 489 17 <sup>(3)</sup>	 5 740 47 <sup>(1)</sup> 5 740 34 <sup>(4)</sup> - Without neutral
Hallways Very long areas	 0 488 17 <sup>(1)</sup>	 0 489 17 <sup>(3)</sup>	 5 740 47 <sup>(1)</sup> 5 740 34 <sup>(4)</sup> - Without neutral
High ceiling areas (gymnasium, storage areas...) <b>IP 55</b>	 0 489 32 (Flush-mounting)	 0 489 33	-
Restrooms, bathrooms Dressing room	 0 488 04 <sup>(3)</sup>	 0 489 16 <sup>(3)</sup>	 5 740 47 <sup>(1)</sup> 5 740 34 <sup>(4)</sup> - Without neutral
<b>OUTDOOR &amp; DAMP AREAS</b>			
Indoor/outdoor car park lot Indoor entrance areas <b>IP 55</b>	 0 489 32  0 489 33 Directional head	 0 489 33 Directional head	-



















1: Surface mounting box option - 2: corner mounting option - 3: 1 lighting output + 1 fan output - 4: Dedicated retrofit solution





# Lighting Management sensors and room controllers for multiple circuits control

## selection chart

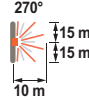
### CHOOSE THE SENSOR

		Automatic On-Off Checking permanently the presence and the light level			
		INSTALLATION			
		Ceiling 		Wall 	
		Surface mounting		Flush-mounting	
<b>WORK AREAS</b>					
Individual office Classroom	 0 488 22	 0 488 23	 0 488 23	 5 740 48	 5 740 48
<b>PASSAGEWAY</b>					
Restrooms, changing rooms...	 0 488 20	 0 488 24	 0 488 24	 5 740 46	 5 740 46
Hallways Very long areas	 0 488 20	 0 488 25	 0 488 25		-
High ceiling areas (gymnasium, storage area...)	-	 0 488 25	 0 488 25		-
<b>OUTDOOR &amp; DAMP AREAS</b>					
Car park lot, cellar, laboratory, test room, changing room	<b>IP 55</b>	-	 0 488 30	 270° 15 m 15 m 10 m	-

### AND THE OUTPUTS TO BE MANAGED

	ON-OFF	DIMMING		
		DALI	1-10 V	Halogen  - Incandescent  - Dimmable LEDs <sup>(1)</sup> 
1 lighting circuit in the same room	0 488 50	0 488 51	0 488 52	0 488 45
1 lighting circuit + fan output in the same room	0 488 50	0 488 51	0 488 52	-
2 lighting circuits in the same room	0 488 50	0 488 51	0 488 52	0 488 45
2 lighting circuits + 1 fan output in the same room	-	0 488 51	-	-
2 lighting circuits (2 inputs, 2 outputs) in 2 rooms	0 488 41	-	0 488 42 (1000 VA)	0 488 45
4 lighting circuits (4 inputs, 4 outputs) in 4 rooms	0 488 43	0 488 44 (max. 32 ballasts)	0 488 43	-
2 lighting circuits + 1 blind output + 1 fan output (4 inputs, 4 outputs) in the same room	0 488 47	-	0 488 47	-

1: Refer to the load table in the data sheet available online in the e-catalogue (**Note:** some commercially available dimmable LEDs are not compatible)

# Motion sensors for 1 circuit

motion sensors for passageway without natural light



Selection chart p. 22

Automatic on/off  
Manual adjustment of light level threshold and time delay via potentiometer  
All load 8.5 A - 240 V

Pack	Cat.Nos	Ideal for passageways	Pack	Cat.Nos	Ideal for outdoor and damp areas
1	0 489 11	<b>Surface mounted on wall</b> PIR wall mounted motion sensor 180° infrared detection, range 8 m Recommended fixing height: 2.5 m 3-wire with neutral IP 42 Light level threshold: 1 to 1000 lux Adjustable time delay: 5 s to 30 min Standby consumption: 0.7 W For direct surface mounting on wall Can be mounted in/on a corner using accessory Cat.No 0 489 71 (p. 28)	1	0 489 31	<b>Surface mounted on wall</b> PIR wall mounted motion sensor 180° infrared detection, range 8 m Recommended fixing height: 2.5 m 3-wire with neutral IP 55 Light level threshold: 5 to 1275 lux Adjustable time delay: 5 s to 30 min Standby consumption: 0.7 W For direct surface mounting on wall Can be mounted in/on a corner using accessory Cat.No 0 489 71 (p. 28)
1	5 740 47	<b>Wall mounted - Arteor</b> PIR wall mounted motion sensors 180° infrared detection, range 8 m Recommended fixing height: 1.2 m IP 41 Light level threshold: 5 to 1275 lux Adjustable time delay: 5 s to 30 min Standby consumption: 0.2 W ○ White - with neutral ○ White - without neutral	1	0 697 40	<b>Ceiling mounted</b> PIR wall and ceiling mounted motion sensor 360° infrared detection with directional head, range Ø8 m Fixes directly to ceiling or wall (min. height: 1.70 m) 3-wire with neutral IP 55 Light level threshold: 1 to 1000 lux Adjustable time delay: 12 s to 16 min Standby consumption: 0.4 W Optimum distance between 2 sensors: 6 m ● Grey ○ White
1	5 740 34		1	0 697 80	
1	0 784 57	<b>Wall mounted - Mosaic</b> PIR wall mounted motion sensor 180° infrared detection, range 8 m Recommended fixing height: 1.2 m IP 41 Without neutral, ideal to replace push-buttons wired to a timer The time delay settings must be the same between the sensor and the timer ○ White			
6	0 488 03	<b>Ceiling mounted</b> PIR ceiling motion sensor 360° infrared detection, range Ø8 m Recommended fixing height: 2.50 m 3-wire with neutral IP 41 Light level threshold: 1 to 1000 lux Adjustable time delay: 5 s to 30 min Consumption: 0.4 W on standby Optimum distance between 2 sensors: 6 m Fixes directly to a false ceiling with mounting claws (included) or installed in a Batibox box, depth 50 mm Can be surface mounted on ceiling using accessory Cat.No 0 488 75 (p. 28)			

# Motion sensors for 1 circuit

## detection areas and load table

### Detection areas

Cat.Nos 5 740 47/34, 0 784 54/55/56 and 0 792 58/59

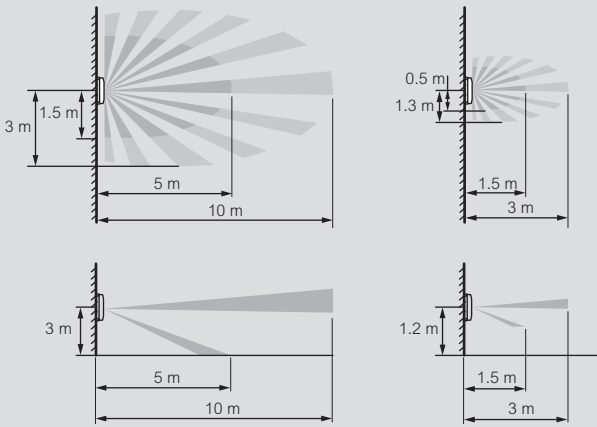

Cat.Nos 0 489 11/31

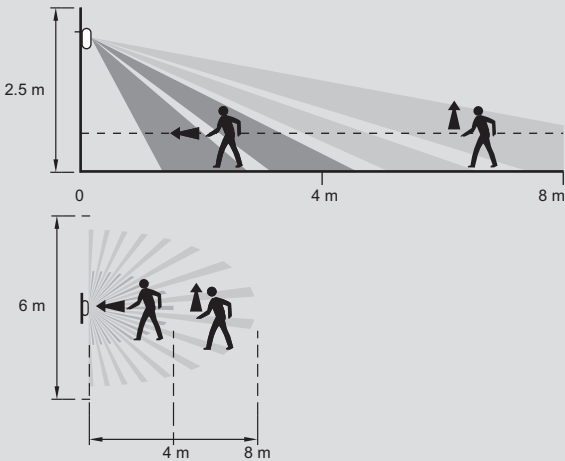

Cat.No 0 488 03

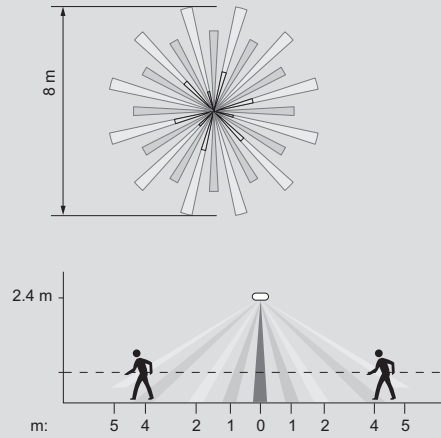

Cat.Nos 0 697 40/80

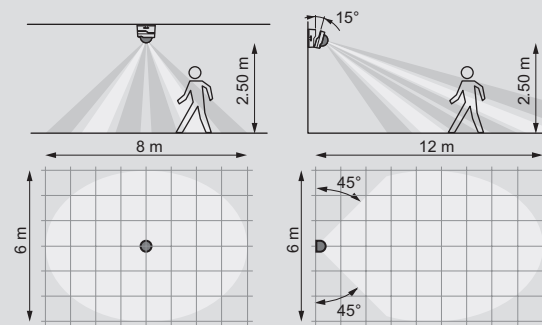

### Load table

Cat.No	Halogen bulb	ELV halogen with ferromagnetic transformer	ELV halogen with electronic transformer	Fluorescent tube	Compact fluorescent bulb	LED
5 740 47	2000 W	1000 VA	1000 VA	10 x (2 x 36 W)	250 W	250 W
5 740 34	40 x 400 W	40 - 400 VA	40 - 400 VA	-	-	-
0 489 11	2000 W	1000 VA	1000 VA	10 x (2 x 36 W)	250 W	250 W
0 488 03	2000 W	1000 VA	1000 VA	10 x (2 x 36 W)	250 W	250 W
0 489 31	2000 W	1000 VA	1000 VA	10 x (2 x 36 W)	250 W	250 W
0 697 40/80	2000 W	1000 VA	1000 VA	10 x (2 x 36 W)	250 W	250 W

# Lighting Management sensors for 1 circuit

## Lighting Management sensors for passageway with natural light



Selection chart **p. 22**  
Load table **p. 29**

Check presence and natural light level continuously, switch off when there is sufficient natural light  
Occupancy mode (automatic switch-on/off factory setting). Can be used with pushbutton Cat.No 0 770 40 (or illuminated pushbutton Cat.No 0 770 33) for vacancy mode (manual switch-on and manual or automatic switch-off). Precise on-site adjustment using configuration tool Cat.No 0 882 30(p. 28)  
Adjustable time delay: 5 s to 59 min. Light level threshold adjustable from 5 to 1275 lux

Pack	Cat.Nos	Ideal for passageways	Pack	Cat.Nos	Ideal for outdoor and damp areas
1	0 488 17	<b>Ceiling mounted</b> Fix directly to a false ceiling with mounting claws (included) or installed in a Batibox box, depth 50 mm, Cat.No 0 893 58 3-wire with neutral Standby consumption: 0.4 W Recommended fixing height: 2.5 m PIR ceiling mounted Lighting Management sensors 360° infrared with detection angle of 2 x 12 m Ideal for hallway IP 41 Optimum distance between 2 sensors: 20 m Connection via automatic terminals Surface mounted on ceiling using accessory Cat.No 0 488 75 (p. 28)	1	0 489 33	<b>Wall or ceiling mounted</b> PIR wall and ceiling mounted multi lens Lighting Management sensors 270° infrared detection with directional head, range 20 m Recommended fixing height: 2.5 m 3-wire with neutral IP 55 Standby consumption: 0.7 W Can be mounted in/on a corner using accessory Cat.No 0 489 72 (p. 28)
1	0 488 07	PIR ceiling mounted Lighting Management sensors 360° infrared detection, range Ø8 m Optimum distance between 2 sensors: 6 m Connection via automatic terminals Surface mounted on ceiling using accessory Cat.No 0 488 75 (p. 28)	1	0 489 32	<b>Ideal for high ceiling areas</b> <b>Ceiling mounted</b> PIR ceiling mounted Lighting Management sensors 360° infrared detection, Ø20 m at 10 m high, Ø8 m at 2.5 m high 3-wire with neutral IP 55, IP 66 with cable gland Cat.No 0 980 23 Optimum distance between 2 sensors: 20 m Standby consumption: 0.4 W Compatible with Cablofil cable trays
1	0 488 08	PIR ceiling mounted Lighting Management sensors 360° infrared detection, range Ø8 m Optimum distance between 2 sensors: 6 m Fast connection	1	5 740 34	<b>Ideal for storage areas and restrooms</b> <b>Wall mounted</b> 180° infrared detection, range 8 m Recommended fixing height: 1.2 m Standby consumption: 0.2 W Optimum distance between 2 sensors: 6 m 2-wire cable (without neutral) IP 41 For installation in box, depth 40 mm min., or in surface mounting box Cat.No 0 802 81 2 modules PIR flush mounted Lighting Management sensors without neutral ○ White
1	0 489 17	<b>Surface mounted on wall</b> PIR wall mounted Lighting Management sensors 180° infrared detection, range 20 m Recommended fixing height: 2.5 m 3-wire with neutral IP 42 Additional 2 A contact for HVAC control based on presence data Standby consumption: 0.4 W Can be mounted in/on a corner using accessory Cat.No 0 489 71 (p. 28)			

# Lighting Management sensors for 1 circuit

## Lighting Management sensors for work areas with natural light



Selection chart **p. 22**  
Load table **p. 29**

Check presence and light level continuously, switch off when there is sufficient natural light

Manual switch-on and manual or automatic switch-off (factory setting)

Can be used with pushbutton Cat.No 0 770 40 (or illuminated pushbutton Cat.No 0 770 33) for manual switch-on and manual or automatic switch-off

Infrared and ultrasonic motion sensors for workplaces, providing precise presence detection as soon as the wave transmitted by the sensor is modified (for example, by hand movement on a keyboard)

Precise on-site adjustment using configuration tool (p. 28)

Pack	Cat.Nos	Ideal for work areas
		Suitable for meeting room, classroom, open plan office, etc.
		<b>Ceiling mounted</b>
		360° infrared and ultrasonic detection, Ø8 m IP 20 3-wire with neutral Optimum distance between 2 sensors: 6 m Standby consumption: 0.8 W Fix directly to a false ceiling with mounting claws (included) or installed in a Batibox box, depth 50 mm
1	0 488 06	Dual technology ceiling mounted Lighting Management sensors Connection via automatic terminals Surface mounted on ceiling using accessory Cat.No 0 488 75 (p. 28)
1	0 488 09	Dual technology ceiling mounted Lighting Management sensors Fast connection
		<b>Surface mounted on wall</b>
1	0 489 14	PIR technology wall mounted Lighting Management sensors with presence output 180° infrared detection, range (front) 8 m Recommended fixing height: 2.5 m 3-wire with neutral IP 42 Additional 2 A contact for HVAC control based on presence data Consumption: 0.4 W on standby Optimum distance between 2 sensors: 10 m Surface mounted on ceiling using accessory Cat.No 0 489 71 (p. 28)
1	0 489 16	Dual technology wall mounted Lighting Management sensors with presence output 180° infrared and ultrasonic detection, range (front) 8 m Recommended fixing height: 2.5 m 3-wire with neutral IP 42 Additional 2 A contact for HVAC control based on presence data Consumption: 0.4 W on standby Optimum distance between 2 sensors: 10 m Surface mounted on ceiling using accessory Cat.No 0 489 71 (p. 28)

Pack	Cat.Nos	Ideal for offices
		<b>Wall mounted</b>
		180° infrared and ultrasonic detection, range 8 m Recommended fixing height: 1.20 m Standby consumption: 0.2 W Optimum distance between 2 sensors: 6 m 3-wire cable IP 41 For installation in box, depth 40 mm min., or in surface mounting box Cat.No 0 802 81 2 modules
1	5 740 49	Dual technology flush mounted Lighting Management sensors with neutral ○ White 
		<b>Ideal for a individual office</b>
		<b>Ceiling mounted</b>
		PIR ceiling mounted Lighting Management sensors 360° infrared detection, Ø8 m range 3-wire with neutral Optimum distance between 2 sensors: 6 m Standby consumption: 0.4 W Fixes directly to a false ceiling with mounting claws (included) or installed in a Batibox box, depth 50 mm Surface mounted on ceiling using accessory Cat.No 0 488 75 (p. 28) IP 41
1	0 488 00	Without 2 A contact for HVAC control
1	0 488 04	Additional 2 A contact for HVAC control based on presence data



Pack	Cat.Nos	Configuration tools for Lighting Management sensors
1	0 882 35	<p>All sensors are supplied with factory settings:</p> <ul style="list-style-type: none"> <li>- 500 lux light level threshold for ceiling mounted sensors, 300 lux for surface and flush mounting sensors</li> <li>- 15-minute time delay and walkthrough function activated</li> </ul> <p>The configuration tools are used to adjust these presets and the detection sensitivity.</p> <p>Step programming on preset buttons</p> <p>Digital programming to one decimal place on the digital screen</p> <p>Instant programming control</p> <p>Used to display the parameters of each sensor</p> <p>Option to store settings in the memory and to apply them to other sensors</p> <p>Standard preset configurations for each room type (office, hallway, etc.) according to EN 12 464</p>
1	0 882 30	
10	0 488 72	<p><b>RJ 45-BUS/SCS connector</b></p> <p>Used to connect controller(s) and sensor(s) to a BUS/SCS cable via tap-off</p> <p>Male connector</p>
10	0 488 68	<p><b>RJ 45 doubler</b></p> <p>Used to double the number of controller inputs</p>
5	0 488 75	<p><b>Surface mounting boxes</b></p> <p>Used for surface mounting ceiling mounted sensors</p> <p>For ceiling mounted sensors Cat.Nos 0 488 04/06/07/17/20/22/35/99</p>
1	0 489 71	<p><b>Fixing accessories for installation in/on corners</b></p> <p>Used to surface mount sensors in/on corners</p> <p>For surface mounting sensors Cat.Nos 0 488 94/95/16/17</p> <p>For surface mounting sensor Cat.No 0 489 33</p>
1	0 489 72	

### ■ Customising settings on-site

All sensors are preset in the factory

- 500 lux light level threshold for ceiling mounted sensors and 300 lux for surface mounting sensors
- 15-minute time delay and walkthrough function activated

The configuration tools are used to adjust the preset settings and the detection sensitivity

### ■ Installing surface mounting boxes Cat.Nos 0 488 74/75

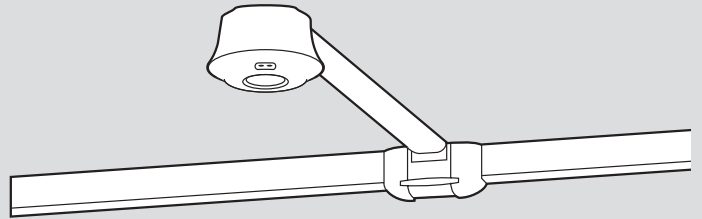

### ■ Installing fixing accessories in/on a corner (view from above)

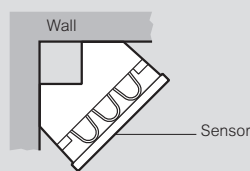

Mounting in internal corner

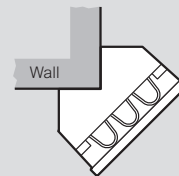

Mounting on external corner

# Motion sensors and Lighting Management sensors for controllers

## Example of how Lighting Management sensors function in an office

Deliberate switch-on action  
 Lighting switches off automatically when there is sufficient natural light, in accordance with standard EN 15 193  
 Meet the requirements of RT 2012

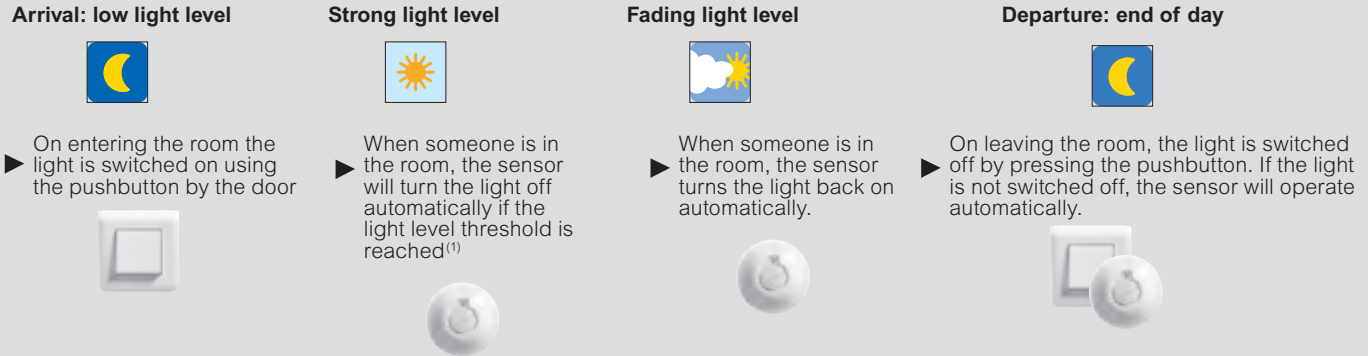

1: Press the pushbutton to keep the light on

## Load table

Cat.No	Halogen bulb	ELV halogen with ferromagnetic transformer	ELV halogen with electronic transformer	Fluorescent tube	Compact fluorescent bulb	LED	Fluorescent bulb with 1-10 V ballast	DALI	Volt-free motor contact
0 488 20/22 0 488 24/30/23/25 0 784 85/86 + 0 488 50	3600 W	1800 VA	1800 VA	10 x (2 x 36 W)	250 W	250 W	-	-	2 A
0 488 20/22 0 488 24/30/23/25 0 784 85/86 + 0 488 51	-	-	-	-	-	-	-	32 ballasts	2 A
0 488 20/22 0 488 24/30/23/25 0 784 85/86 + 0 488 52	-	-	-	-	-	-	1000 VA	-	-
0 488 04	2000 W	1000 VA	1000 VA	10 x (2 x 36 W)	250 W	250 W	-	-	2 A
0 488 07/08	2000 W	1000 VA	1000 VA	10 x (2 x 36 W)	250 W	250 W	-	-	-
0 488 06/09	2000 W	1000 VA	1000 VA	10 x (2 x 36 W)	250 W	250 W	-	-	-
0 488 17	2000 W	1000 VA	1000 VA	10 x (2 x 36 W)	250 W	250 W	-	-	-
0 784 53 - 0 792 53	40-400 W	40-400 VA	40-400 VA	-	-	20-150 W <sup>(1)</sup>	-	-	-
0 784 52 - 0 792 52	2000 W	1000 VA	1000 VA	10 x (2 x 36 W)	250 W	250 VA	-	-	-
0 489 16	2000 W	1000 VA	1000 VA	10 x (2 x 36 W)	250 W	250 VA	-	-	2 A
0 489 17	2000 W	1000 VA	1000 VA	10 x (2 x 36 W)	250 W	250 VA	-	-	2 A
0 489 32	2000 W	1000 VA	1000 VA	10 x (2 x 36 W)	250 W	250 VA	-	-	-
0 489 33	2000 W	1000 VA	1000 VA	10 x (2 x 36 W)	250 W	250 VA	-	-	-

1: Operates with dimmable LEDs



# Lighting Management sensor for managing several circuits

multi-circuit ceiling mounted controllers for areas with natural light



## Local control solutions

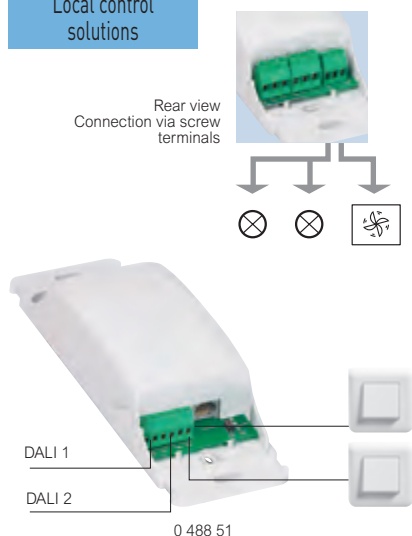

## Sensor and controller selection chart p. 23

Ceiling mounted or installed in Cablofil cable trays (see Legrand Cable Management catalogue)  
 Connection to sensors (Cat.Nos 0 488 20/22/30/24/23/25 and 0 784 85/86) by cord or RJ 45 cable or BUS/SCS cable to be fitted with RJ 45 connector Cat.No 0 488 72 (p. 31)

Pack	Cat.Nos	For controlling 1 or 2 circuits in one room	Pack	Cat.Nos	For controlling 4 lighting circuits
1	0 488 50	1 sensor input, 2 inputs for auxiliaries 2 outputs Can be used with a pushbutton, including a pushbutton with LED indicator, Cat.Nos 0 770 40/33 for manual switch-on and manual or automatic switch-off <b>ON/OFF</b> 2 x 16 A outputs Used to control 2 ON/OFF lighting circuits or 1 lighting circuit + 1 ventilation circuit Connection via screw terminals	1	0 488 43	Can be controlled for each output by a sensor and/or an individual BUS control unit Addressing methods using sensors and control units: - automatic configuration - custom configuration by pressing the "Learn" button on the product <b>Dimming - ballast 1-10 V or ON/OFF</b> 4 outputs 1000 VA maximum per output
1	0 488 51	<b>Dimming - DALI ballast</b> 2 DALI outputs (32 ballasts max.) and 1 ventilation output (volt-free contact) Used to dim the light level on the window side of a room (where there is more natural light) separately from the corridor side Used to control a maximum of 32 DALI ballasts Connection via screw terminals	1	0 488 44	<b>Dimming - DALI ballast</b> 4 outputs 32 ballasts maximum per output
1	0 488 52	<b>Dimming - 1-10 V ballast</b> 2 x 1000 VA lighting outputs Used to dim the light level on the window side of a room (where there is more natural light) separately from the corridor side Connection via screw terminals	1	0 488 47	<b>For controlling 2 lighting circuits, 1 shutter and 1 HVAC contact</b> Can be controlled for each output by a sensor and/or an individual BUS control unit Addressing methods using sensors and control units: - automatic configuration - custom configuration by pressing the "Learn" button on the product 2 ON/OFF or 1-10 V dimming lighting outputs 1 output for roller blind 1 ventilation output (volt-free contact)
1	0 488 41	<b>For controlling 2 lighting circuits</b> Can be controlled for each output by a sensor and/or an individual BUS control unit Addressing methods using sensors and control units: - automatic configuration - custom configuration by pressing the "Learn" button on the product <b>ON/OFF</b> 2 x 16 A outputs			
1	0 488 42	<b>Dimming - 1-10 V ballast</b> 2 outputs 1000 VA maximum per output			
1	0 488 45	<b>Dimming - LV and ELV halogen</b> 2 outputs 1000 W maximum per output			



# Lighting Management sensors for managing several circuits

## Lighting Management sensors for controllers for passageway and work areas with natural light



### Local control solutions

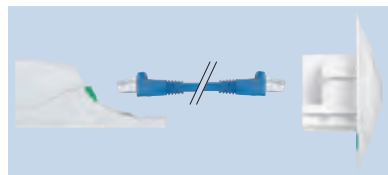

Connection to controller via cord or RJ 45 cable



0 488 25  
(IR detection)



5 740 48



0 488 22  
(IR + US detection)



0 488 23  
(IR + US detection)

### Sensor and controller selection chart p. 23

Check presence and light level continuously, switch off when there is sufficient natural light

Automatic switch-on/off (factory setting)

Precise on-site adjustment using configuration tool (p. 28)

Connect to controllers by cord or RJ 45 cable or BUS/SCS cable to be fitted with RJ 45 connector Cat.No 0 488 72 (p. 28)

Pack	Cat.Nos	Ideal for large areas	Pack	Cat.Nos	Ideal for work areas
1	0 488 20	<b>Ceiling mounted</b> 360° infrared detection, range Ø8 m Optimum distance between 2 sensors: 6 m Consumption: 0.2 W on standby Fixes directly to a false ceiling with mounting claws (included) or installed in a Batibox box, depth 50 mm Surface mounted on ceiling using accessory Cat.No 0 488 75 IP 41	1	5 740 48	<b>Wall mounted</b> 180° infrared and ultrasonic detection, range 8 m Recommended fixing height: 1.2 m IP 41 Consumption: 0.2 W on standby Integrated pushbutton For installation in box, depth 40 mm min., or in surface mounting box Cat.No 0 802 81 2 modules
1	0 488 25	<b>Surface mounted</b> 140° infrared detection with directional head, range 30 m IP 42 Consumption: 0.2 W on standby Supplied with fixing plate	1	0 488 22	<b>Ceiling mounted</b> 360° infrared and ultrasonic detection, range Ø8 m Recommended fixing height: 2.50 m Optimum distance between 2 sensors: 6 m Consumption: 0.5 W on standby Fixes directly to a false ceiling with mounting claws (included) or installed in a Batibox box, depth 50 mm Surface mounted on ceiling using accessory Cat.No 0 488 75 (p. 28) IP 20
1	5 740 46	<b>Wall mounted</b> 180° infrared detection, range 8 m Recommended fixing height: 1.2 m IP 41 Consumption: 0.2 W on standby Integrated pushbutton For installation in box, depth 40 mm min., or in surface mounting box Cat.No 0 802 81 2 modules	1	0 488 23	<b>Surface mounted</b> 180° infrared and ultrasonic detection with directional head, range (front) 7 m IP 42 Consumption: 0.5 W on standby Supplied with fixing plate
1	0 488 24	<b>Surface mounted</b> 180° infrared detection with directional head, range (front) 5 m IP 42 Consumption: 0.2 W on standby Supplied with fixing plate	1	0 488 28	<b>Light level measurement cell</b> For synchronising the light level measurement when used with sensors Use the configuration tool Cat.No 0 882 30 (p. 28) to configure the light level cell Connects to the BUS/SCS cable with connector Cat.No 0 488 72 (p. 28) IP 20
1	0 488 30	<b>Ideal for outdoor and damp areas</b> <b>Surface mounted</b> 270° dual infrared detection, side range 2 x 15 m and front range 10 m IP 55 Consumption: 0.5 W on standby Supplied with fixing plate	10	0 488 72	<b>RJ 45-BUS/SCS connectors</b> Used to connect controller(s) and sensor(s) to a BUS/SCS cable via tap-off Male connector
			10	0 488 73	Female connector



# Local or global control,

## the choice is yours!

Once you have selected your sensors and controls, you can opt for a local BUS/SCS solution or a BUS/KNX building control system.

### LOCAL CONTROL

BUS/SCS wiring enables local and remote presence and light level detection and management, shutter control, time management and scenario management functions. Ideal for meeting rooms, small businesses or office spaces etc.



### BUILDING CONTROL

In addition to local control, BUS/KNX wiring enables supervision and integration of other building applications, such as emergency lighting, HVAC and fire alarms. An ideal solution to the needs of energy performance, operating performance and ease of maintenance.







## RADIO/ZIGBEE®: THE PERFECT COMPLEMENT TO BUS/SCS



As an addition to BUS/SCS wiring, the Radio/ZigBee® offer can be used to install new radio control points without damaging walls. Ideal for refurbishment installations or glazed surfaces.



- Connection:
  - To the BUS/SCS controller via cord or RJ 45 cable or BUS/SCS cable to be fitted with RJ 45-BUS/SCS connector Cat.No 0 488 72 (p. 28)
  - Directly to the BUS/SCS cable (supplied with BUS/SCS connector Cat.No 3515 for connection to the BUS/SCS cable via tap-off)
  - To be fitted with Mosaic cover plates and Batibox support frames

Pack	Cat.Nos	ON/OFF lighting controls
		Pushbutton control used to control 1 controller
		<b>1 way</b> Used to control 1 lighting circuit (1 output)
1	0 784 75	 <ul style="list-style-type: none"> <li>○ White</li> <li>● Aluminium</li> </ul>
1	0 791 75	
		<b>2 way</b> Used to control 2 lighting circuits (2 outputs)
1	0 784 72	 <ul style="list-style-type: none"> <li>○ White</li> <li>● Aluminium</li> </ul>
1	0 791 72	
		<b>Switch multifunction controls</b>
		Used to control several controllers (or several outputs on one or more controllers): ON/OFF, dimming, ventilation, roller blind
		<b>1 way</b>
1	0 784 71	 <ul style="list-style-type: none"> <li>○ White</li> <li>● Aluminium</li> </ul>
1	0 791 71	
		<b>2 way</b>
1	0 784 73	 <ul style="list-style-type: none"> <li>○ White</li> <li>● Aluminium</li> </ul>
1	0 791 73	
		<b>Scenario controls</b>
		Used to control several controllers
		<b>2 scenarios</b> 4 buttons used to manage the start and end of each scenario Example: adjusting lighting levels, controlling lighting with blind, etc.
1	0 784 78	 <ul style="list-style-type: none"> <li>○ White</li> <li>● Aluminium</li> </ul>
1	0 791 78	

# As well as the lighting, optimise operating performance

For optimum energy performance and maintenance, you need active management solutions for all the equipment in the building.

With global control, Legrand becomes an active part of new generation buildings, responding to all their requirements.

ISOZ 50000/HQE/LEED/BREEAM/SMART GRID READY

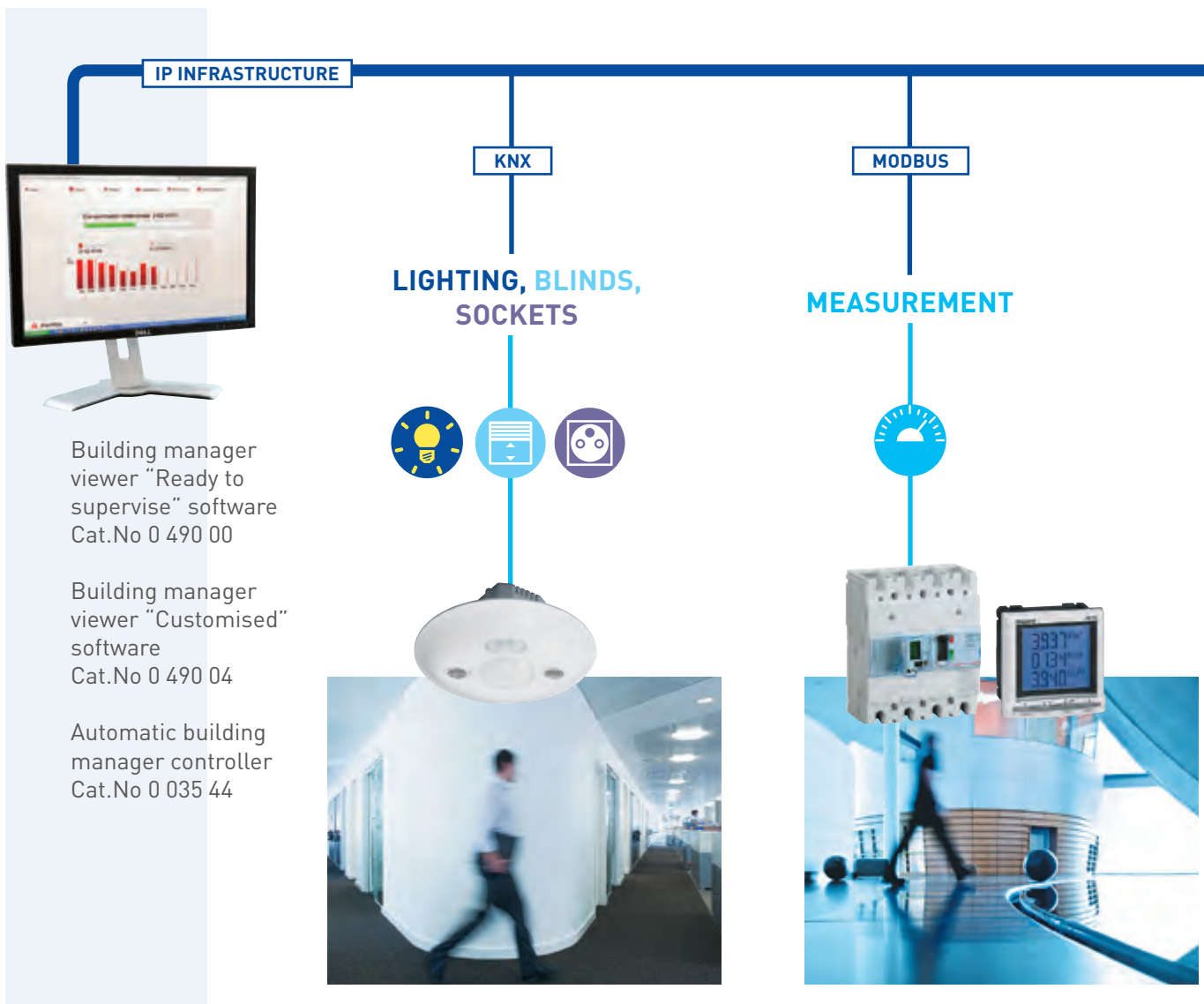

Building manager viewer "Ready to supervise" software  
Cat.No 0 490 00

Building manager viewer "Customised" software  
Cat.No 0 490 04

Automatic building manager controller  
Cat.No 0 035 44



FOLLOW US  
ALSO ON

@ website: [www.legrand.com](http://www.legrand.com)

 [www.youtube.com/legrand](http://www.youtube.com/legrand)

 [www.twitter.com/legrand](http://www.twitter.com/legrand)



**Head office**

and International Department  
87045 Limoges Cedex - France  
Tel: + 33 (0) 5 55 06 87 87  
Fax: + 33 (0) 5 55 06 74 55